

M27 (Maintenance Free Starting Battery)
SMF 27MS-780 (12V 95Ah)

ROCKET Starting Batteries are always to be a step ahead of this competitors. If you have driven your car in freezing temperatures, you know the ignition doesn't always start as easily as you want. What you need is a powerful battery, ROCKET, from the largest battery manufacturer in Korea. With the overwhelming power of ROCKET, you will always be the first one out of the blocks.

Design Features

- Designed to keep a proper level of electrolyte in the upper part of plates via accommodating an acid volume by 10mm or so higher than competitors' to sustain an acid volume in case of water consumption caused by evaporation at a high temperature.
- Application of cold-forged bushing & leakage-proof.
- An increase of lifespan via adoption of spun-bonded paper.
- An increment of anti-corrosion & lifespan via an adoption of grid in high SN (tin).
- Double lid with labyrinth structure – prevent electrolyte losses by collection and returning liquid to the reservoir & vents allow the battery to “breathe” during temperature changes and charging.

Performance Characteristics		
	Length	304 mm
	Width	173 mm
	Total Height (include Terminal)	225 mm
	Approx Weight	21.7 kg
	Nominal Voltage	12 Volt
	Number of Cells	6
	Nominal Capacity (20 hour rate)	95 Ah
	Nominal Capacity (5 hour rate)	76 Ah
	Cold Cranking Amps @ -18°C	780
	Cranking Amps @ 0°C	910
	Reserve Capacity	130 minutes
	Terminal	TM
	Battery Standard	BCI

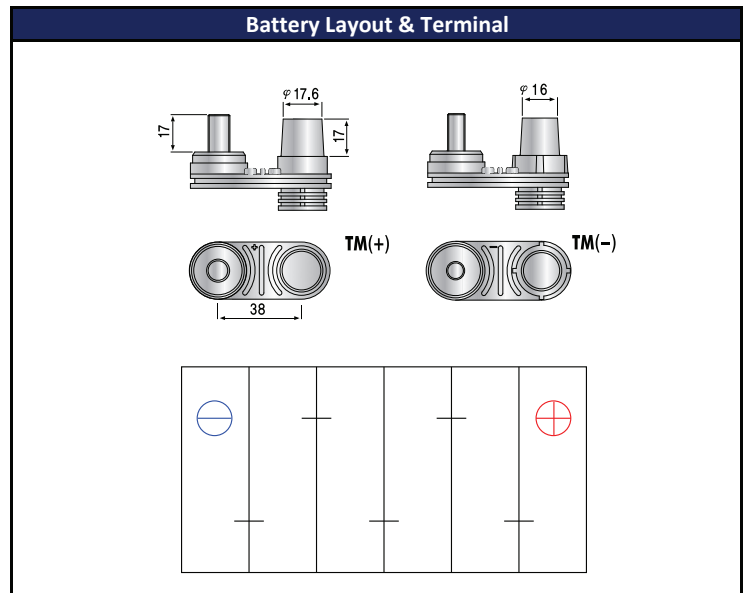
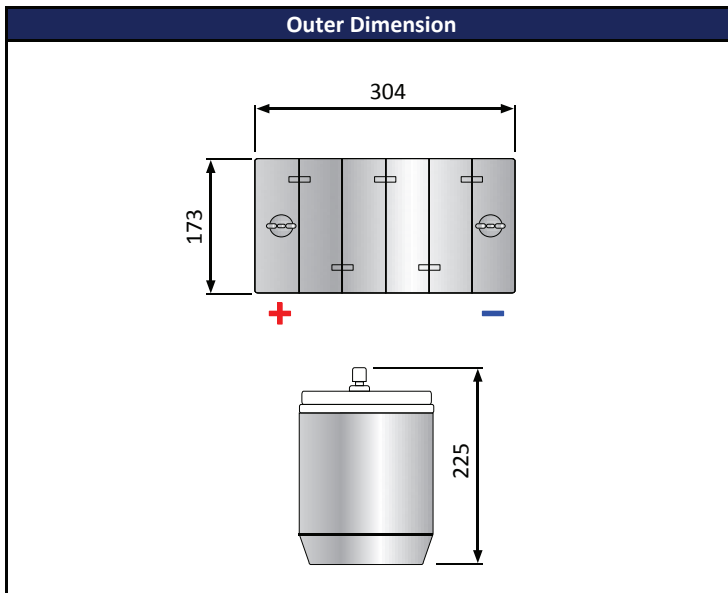

Battery Replacement Procedure

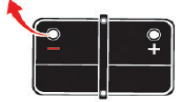
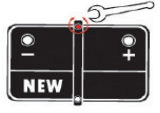
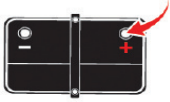
			
Step 1 Switch off the engine and keep sparks, flames, cigarettes away from battery at all times, before removing the old battery.	Step 2 Disconnect the negative terminal first and avoid short-circuit caused by tools, when removing old battery.	Step 3 Clean corroded parts in tray and cable clamps, before installation of new battery.	Step 4 Connect the positive terminal first and check the terminal clamps for tight fit, when installing new battery.

Above data provided from tested samples is generally for descriptive only. It is not intent to make or imply any representation; guarantee or warranty with respect to any battery cell. Battery cell designs/specifications are subject to modify without prior notice.