



MASTER CosmoWhite CPO-TW & CPO-TW Xtra



MST CosmoWh CPO-TW Xtra 60W/728 PGZ12

New-generation ceramic metal halide lamps used in Outdoor offering efficient and pleasant white light

Warnings and Safety

- Use only in totally enclosed luminaire, even during testing (IEC61167, IEC 62035, IEC60598)
- The luminaire must be able to contain hot lamp parts if the lamp ruptures
- Use only with electronic control gear
- Control gear must include end-of-life protection (IEC61167, IEC 62035)
- A lamp breaking is extremely unlikely to have any impact on your health. If a lamp breaks, ventilate the room for 30 minutes and remove the parts, preferably with gloves. Put them in a sealed plastic bag and take it to your local waste facilities for recycling. Do not use a vacuum cleaner.

Product data

General Information		Operating and Electrical	
Cap-Base	PGZ12	Chromaticity Coordinate Y (Nom)	0.4
Operating Position	UNIVERSAL [Any or Universal (U)]	Correlated Color Temperature (Nom)	2800 K
Flux measurement reference	Sphere	Luminous Efficacy (rated) (Nom)	120 lm/W
Life to 50% Failures (Nom)	32,000 hour(s)	Color rendering index (CRI)	73
		Arc Length O (Nom)	14 mm
Light Technical			
Color Code	728 [CCT of 2800K]	Power Consumption	60.0 W
Luminous Flux	7,200 lm	Voltage (Nom)	92 V
Color Designation	White (WH)		
Chromaticity Coordinate X (Nom)	0.447		

MASTER CosmoWhite CPO-TW & CPO-TW Xtra

Controls and Dimming

Dimmable	Yes
----------	-----

Mechanical and Housing

Bulb Finish	Clear
Bulb Shape	T19
Net Weight (Piece)	0.034 kg

Approval and Application

Energy Efficiency Class	E
Mercury (Hg) Content (Max)	2 mg
Mercury (Hg) Content (Nom)	2.0 mg
Energy Consumption kWh/1000 h	60 kWh
EPREL Registration Number	473348

CE mark	Yes
---------	-----

Product Data

Order product name	MST CosmoWh CPO-TW Xtra 60W/728 PGZ12
Full product name	MST CosmoWh CPO-TW Xtra 60W/728 PGZ12
Full product code	87115002085145
Order code	928088505127
Material Nr. (12NC)	928088505127
Numerator - Quantity Per Pack	1
EAN/UPC - Product/Case	8711500208514
Numerator - Packs per outer box	12
EAN/UPC - Case	8711500208521

Dimensional drawing

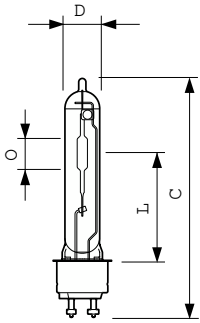

Product	D (max)	D	O	L	C (max)
MST CosmoWh CPO-TW Xtra 60W/728 PGZ12	20 mm	19 mm	14 mm	59 mm	132 mm

Photometric data

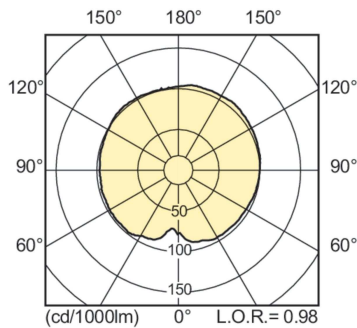

Light Distribution Diagram - MST CosmoWh CPO-TW Xtra 60W/728 PGZ12

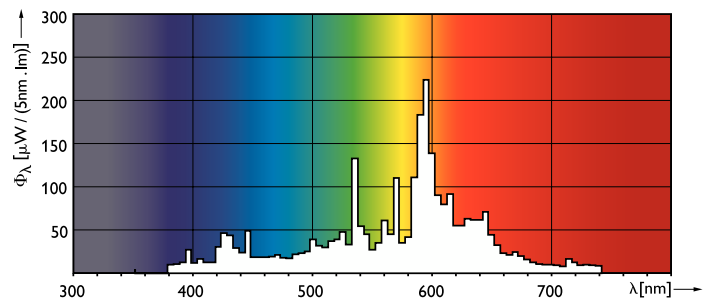

Spectral Power Distribution Colour - MST CosmoWh CPO-TW Xtra 60W/728 PGZ12

MASTER CosmoWhite CPO-TW & CPO-TW Xtra

Lifetime

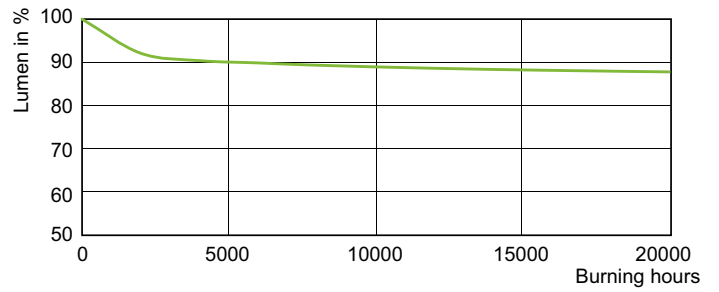
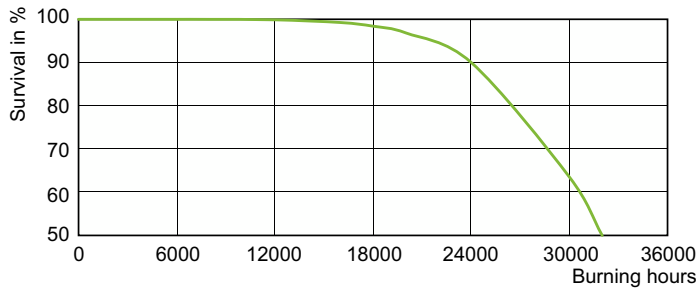

LDLE_CPO-TW_0006-Life expectancy diagram

Lumen Maintenance Diagram - MST CosmoWh CPO-TW Xtra 60W/728 PGZ12

