

## LED Intelligent Driver (constant voltage)

- Dimming interface: DALI (IEC62386), Push DIM.
- Dimming range from 0-100%, LED start at 0.1% possible.
- 0-100% flicker-free ,High frequency exemption level.
- High Efficient driver: efficiency 93%, PF>0.98, THD<6%.
- In line with the EU energy efficiency ERP directive, standby power consumption < 0.5W.
- Innovative thermal management technology, intelligent power life protection.
- Over-heat / Over voltage / Over load / Short circuit protection, recover automatically.
- Fully-protected plastic housing with design of dismantlable end cover.
- DALI bus standard: IEC62386-101,102, 207.
- Suitable for internal lights application for I / II / III.
- Up to 50,000-hour life time.
- 5 years warranty (Rubycon capacitor).

### Flicker-free

IEEE 1789  
Achieve the exemption level.

### Dimmable:

0.1%-100%

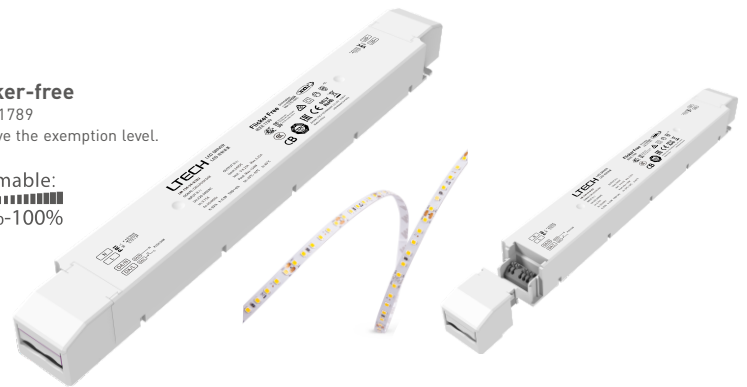

**SELV Class 2**  
**RoHS**



The certification icon represents undergoing certification applications only, and final certification qualification subject to actual product.



## Specification

Model	LM-150-24-G1D2	LM-150-12-G1D2	
OUTPUT	Output Voltage	24Vdc	12Vdc
	Output Voltage Range	24Vdc ± 0.5Vdc	12Vdc ±0.5Vdc
	Output Current	Max. 6.25A	Max. 12.5A
	Output Power	Max. 150W	
	Output Power Range	0~150W	
	Strobe Level	High frequency exemption level.	
	PWM Frequency	3600Hz	
	Dimming Range	0~100%, dimming depth: Max. 0.1%	
	Overload Power Limitation	≥102%	
Ripple & Noise	Switch ripple<200mV, noise<500mV	Switch ripple<200mV, noise<800mV	
INPUT	Dimming Interface	DALI (IEC62386), Push DIM	
	Input Voltage	220-240Vac	200-280Vdc
	Frequency	50/60Hz	
	Input Current	Max. 0.75A/230Vac	
	Power Factor	PF>0.98/230Vac, at full load	
	THD	<6% at 230Vac, at full load	
	Efficiency (typ.)	93%	92%
	Standby Power Loss	<0.5W	
	Inrush Current(typ.)	Cold start 45A at 230Vac	
	Control surge capability	L-N:2KV	
Leakage Current	Max. 0.5mA		
ENVIRONMENT	Working Temperature	ta: -20°C ~ 50°C tc: 85°C	
	Working Humidity	20 ~ 95%RH, non-condensing	
	Storage Temp., Humidity	-40°C ~ 80°C, 10-95%RH	
	Temp. Coefficient	±0.03%/°C (0-50°C)	
	Vibration	10-500Hz, 2G 12min./1cycle, period for 72min. each along X, Y, Z axes	
PROTECTION	Over-heat Protection	Intelligently adjusting or turning off the output current if the PCB temperature>110°C, auto recovers	
	Over Voltage Protection	Shut down the output when non-load voltage>28V, re-power on to recover after fault condition is removed	Shut down the output when non-load voltage>16V, re-power on to recover after fault condition is removed
	Over Load Protection	Shut down the output when current load>102%, auto recovers.	
	Short Circuit Protection	Enter hiccup mode if short circuit occurs, auto recovers.	
SAFETY & EMC	Withstand Voltage	I/P-O/P: 3750Vac	
	Isolation Resistance	I/P-O/P: 100MΩ/500VDC/25°C/70%RH	
	Safety Standards	IEC/EN61347-1, IEC/EN61347-2-13	
	EMC Emission	EN55015, EN61000-3-2 Class C, IEC61000-3-3	
	EMC Immunity	EN61000-4-2,3,4,5,6,8,11 EN61547	
	Strobe Test Standard	IEEE 1789	
OTHERS	Weight(G.W.)	430g±10g	
	Dimensions	352×43×30mm[L×W×H]	
	Package Size	355×44×33mm[L×W×H]	
	Coton Size	370×340×93mm[L×W×H] 20pcs/ctn 9.4kg±5%/ctn	

\* The driver is suitable for connecting resistor current-limiting LED fixture (e.g. LED strip). The inrush current will be dozens of times times increased if connecting built-in constant current IC current-limiting LED fixtures, the driver will activate the overloaded protection (hiccups flickering). When you order, please remark controlling the constant current LED fixture (e.g. MR16 lamp, underground light, LED wall washer, constant current LED strip, etc.), then we can prepare the special programs.

## Dimensions

Unit: mm

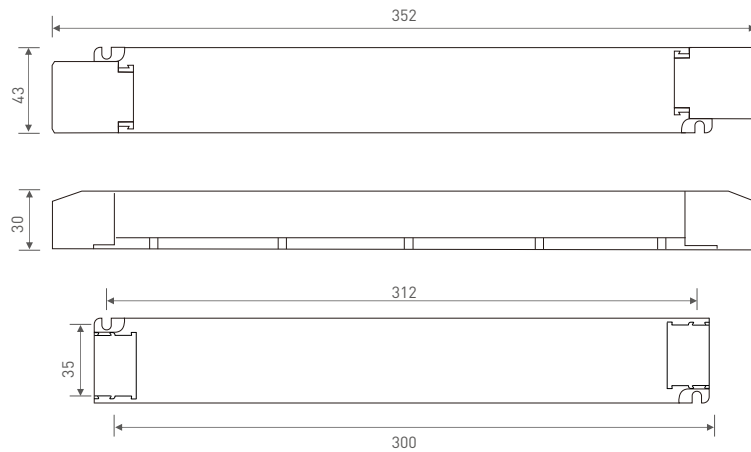

## Wiring Diagram

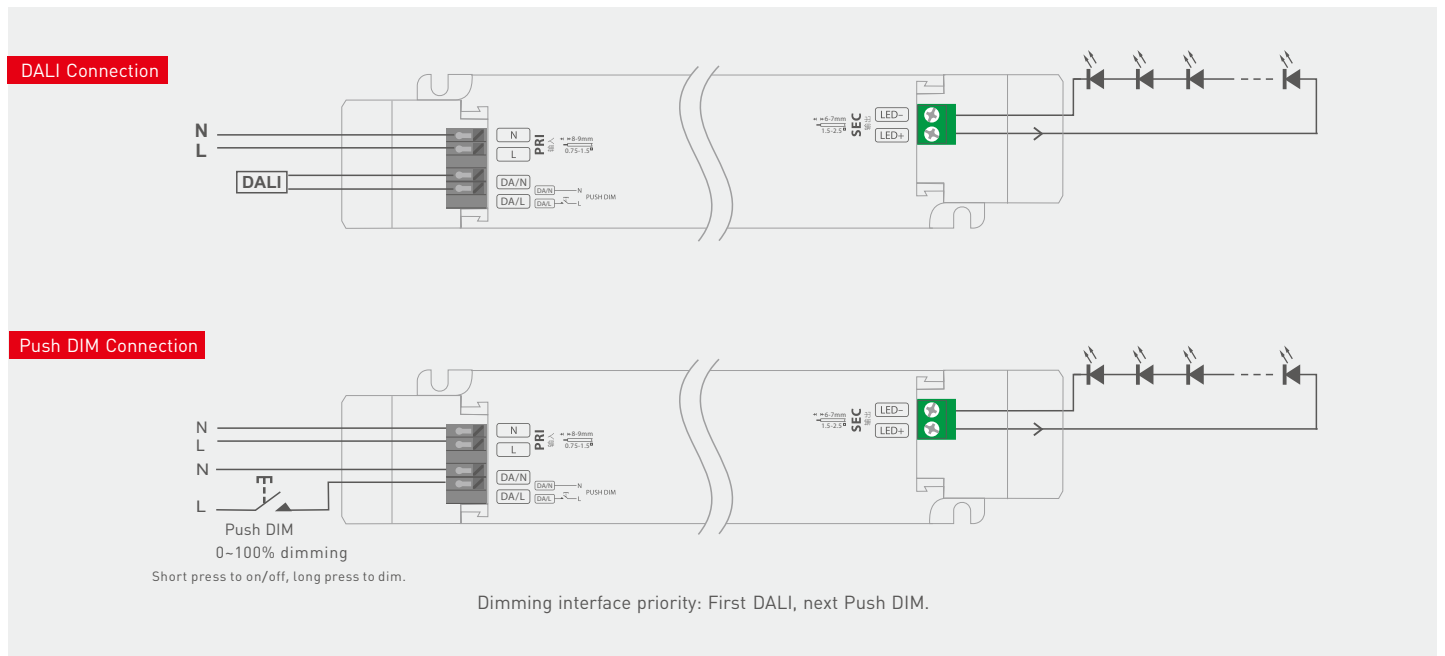

## Push DIM



Reset switch

- On/off control: Short press.
- Stepless dimming: Long press.
- With every other long press, the brightness goes to the opposite direction.
- Dimming memory: Brightness will be the same as previously adjusted when turning on again.

## Application of Protective Cover

Wire pressing board:

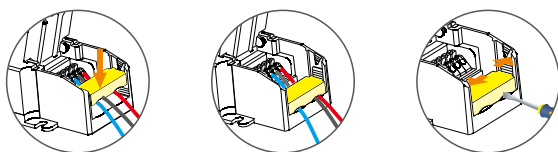

Push the wire pressing board to fix the wires.

Push outward the side plate, meanwhile use the tool to uninstall the wire pressing board.

Uninstall protective cover:

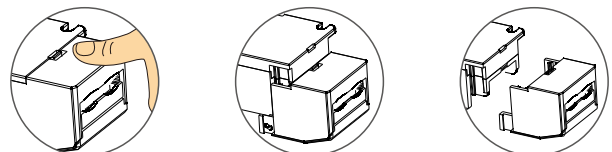

Break off the bottom left and right to remove the protective cover.

## Relationship Diagrams

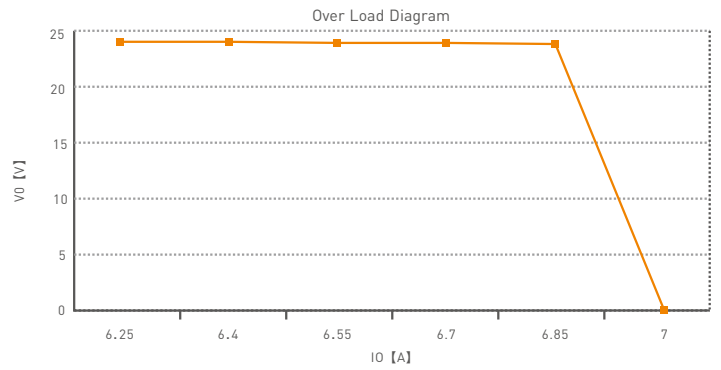
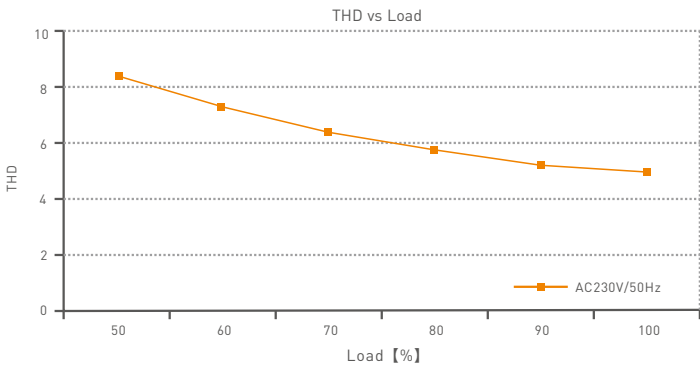
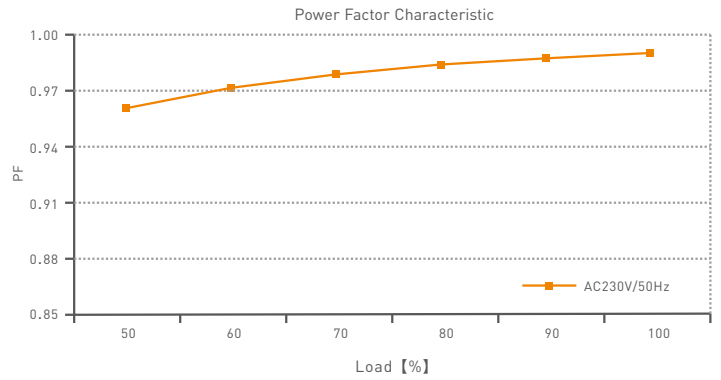
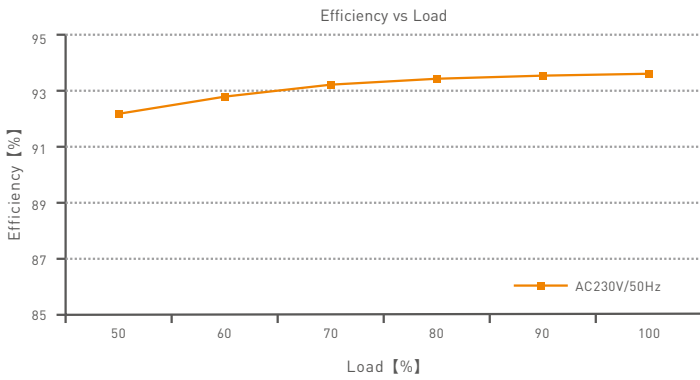

LM-150-24-G1D2

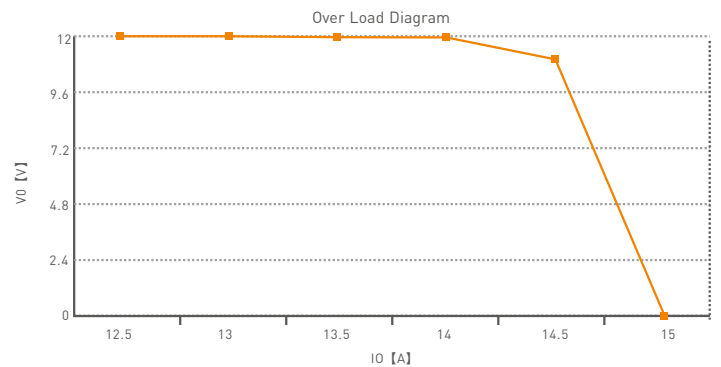
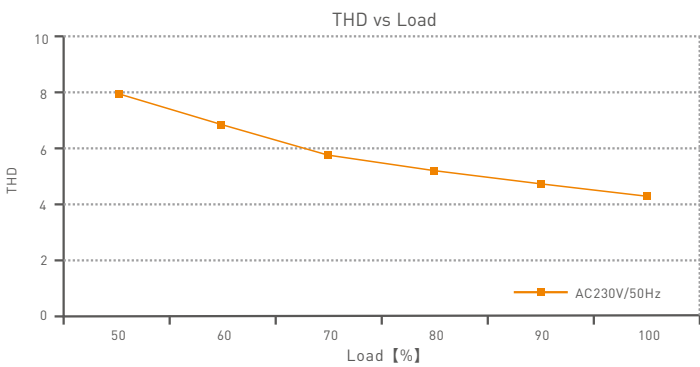
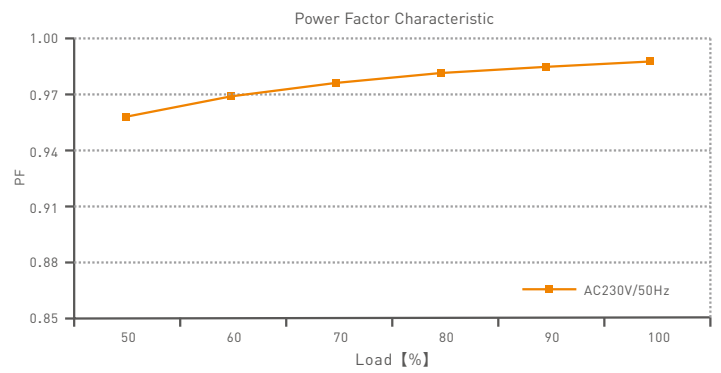
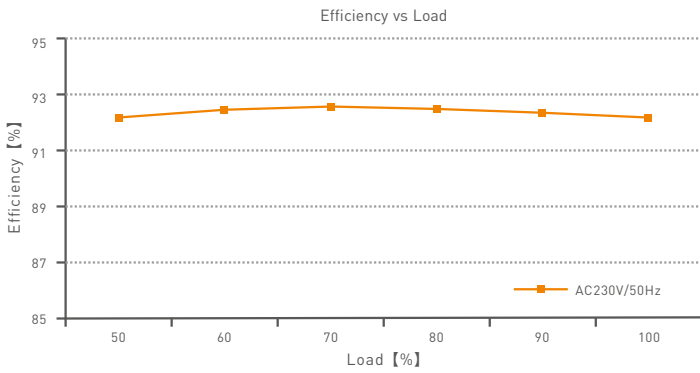

LM-150-12-G1D2

## Flicker Test Form

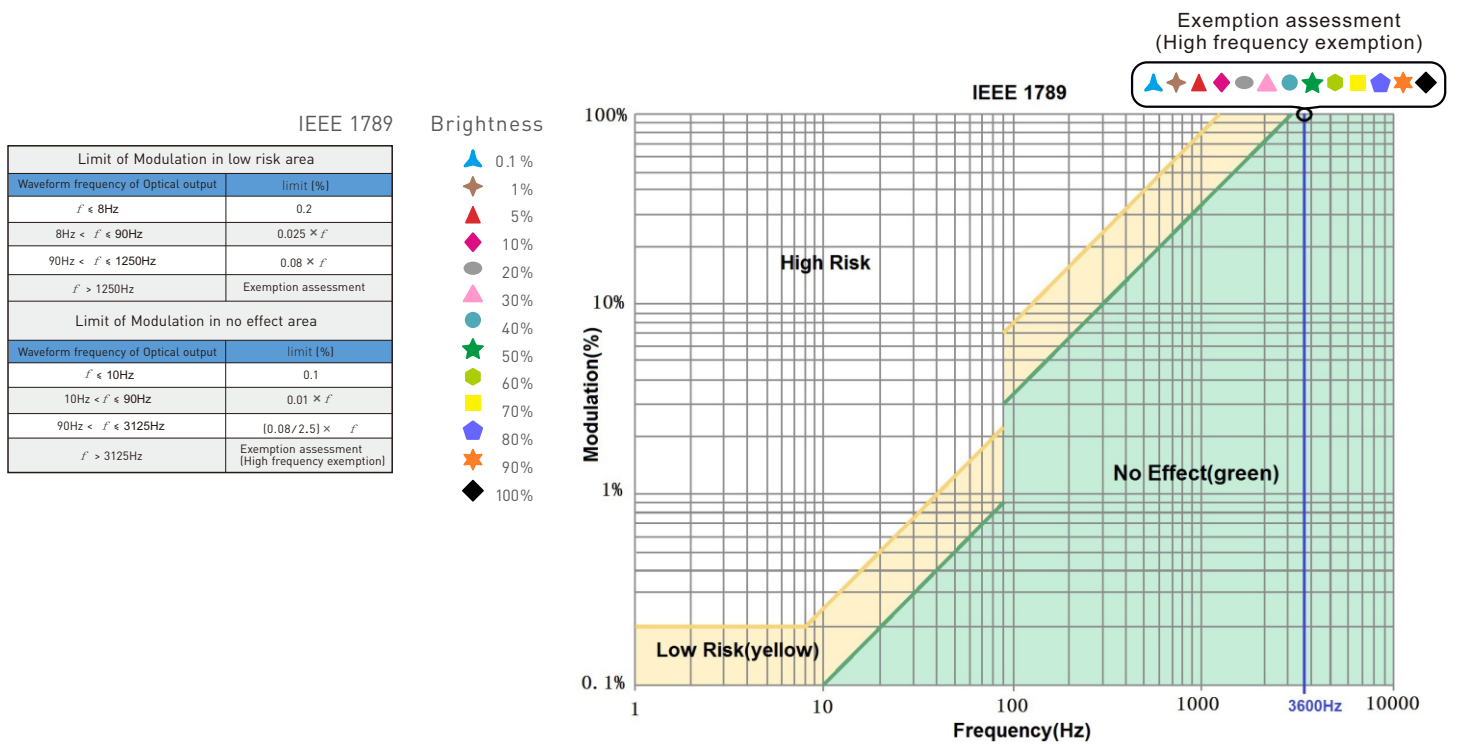

## Attentions

- Products shall be installed by qualified professionals.
  - LTECH products are non-waterproof (special models excepted). Please avoid the sun and rain. When installed outdoors, please ensure it is mounted in a water proof enclosure.
  - Good heat dissipation will extend the working life of products. Please ensure good ventilation.
  - Please check if the working voltage used complies with the parameter requirements of products.
  - The diameter of wire used must be able to load the light fixtures you connect and ensure the firm wiring.
  - Before you power on products, please make sure all the wiring is correct in case of incorrect connection that causes damage to light fixtures.
  - If a fault occurs, please do not attempt to fix products by yourself. If you have any question, please contact your suppliers.
- \* This manual is subject to changes without further notice. Product functions depend on the goods. Please feel free to contact our official distributors if you have any question.

## Warranty Agreement

- Warranty periods from the date of delivery: 5 years.
- Free repair or replacement services for quality problems are provided within warranty periods.

Warranty exclusions below:

- Beyond warranty periods.
- Any artificial damage caused by high voltage, overload, or improper operations.
- Products with severe physical damage.
- Damage caused by natural disasters and force majeure.
- Warranty labels and barcodes have been damaged.
- No any contract signed by LTECH.

1. Repair or replacement provided is the only remedy for customers. LTECH is not liable for any incidental or consequential damage unless it is within the law.
2. LTECH has the right to amend or adjust the terms of this warranty, and release in written form shall prevail.