

Emergency Luminaire for Fluorescent Lamps

Series EXLUX 6009



www.stahl.de



16126E00

- > As wall, ceiling and pendant light fitting or pole mounted light fitting
- > Version with 2 lamps: 18 W and 36 W
- > Central locking
- > All-pole disconnection via N/C switch when opening light fitting or battery enclosure
- > Weekly functional test
- > Light duration test of the emergency lighting once a year

E2



The lights of the Series **EXLUX 6009** can be used as emergency lighting

Zone	ATEX / IECEx					
	0	1	2	20	21	22
For use in		x	x		x	x

WebCode 6009A

Emergency Luminaire for Fluorescent Lamps

Series EXLUX 6009

Selection Table

Version	Lamps W	Battery	Lighting hours	Order number	Weight kg
Standard luminaire Series 6009	2 x 18	7 Ah	1.5 / 3 h (emergency light)	6009/522-9617-1611-7	7.600
	2 x 36	7 Ah	1.5 / 3 h (emergency light)	6009/542-9617-1611-7	9.650

Order Number Supplement

Through wiring	without	6.09/...-0.....
	with 6 conductors	6.09/...-6.....
ECG	220 ... 240 V	6.09/...-7.....
	110 ... 127 V	6.09/...-6.....
Connection terminal	Cage clamp terminal type WAGO 0.5 ... 4 mm ²	6.09/...-1.....
	Screw-type terminal type STAHL 1.5 ... 6 mm ²	6.09/...-2.....
Cable glands	Standard 2 x M25 x 1.5 cable gland and 1 x M25 x 1.5 stopping plugs	6.09/...-1.-.
	Special 2 x M20 x 1,5 cable gland and 1 x M20 x 1,5 stopping plug	6.09/...-2.-.
Emergency duration test	with	6.09/...-7
	without	6.09/...-8

Note

The lights are delivered without fluorescent lamps and assembly parts.
These parts must be ordered separately!

Explosion Protection

Global (IECEx)

Gas and dust

Ex d e mb IIC T4 Gb or Ex db eb mb IIC T4
Ex tb IIIC T80 °C Db or Ex tb IIIC T80 °C

Europe (ATEX)

Gas and dust

⊕ II 2 G Ex d e mb IIC T4 Gb or Ex db eb mb IIC T4
⊕ II 2 D Ex tb IIIC T80°C Db or Ex tb IIIC T80 °C

Certifications and certificates

Certificates

IECEx, ATEX

Technical Data

Electrical data

Rated voltage

Standard:
• 220 ... 240 V ± 10%, 50 / 60 Hz (Lamps acc. IEC60081)
Optional:
• 110 ... 127 V ± 10%, 50 / 60 Hz (Lamps acc. IEC60081)
• 120V ± 10%, 50 / 60 Hz (Lamps acc. ANSI IEC C78.81)

Rated insulation voltage

320 V

Disconnection of the light

When opening the light

Switch with safety lock; when opening the central lock, all poles of the voltage supply to the ballast are disconnected; contacts of the switching element are NC contacts, they can only be switched on again when the lamp cover and the central locking system are closed.

In case of a lamp fault, the electronic ballast disconnects the defective lamp from the power supply.

Emergency Luminaire for Fluorescent Lamps

Series EXLUX 6009



Technical Data

Luminous characteristics

Lamps	2x 18 W; 2x 36 W (acc. to IEC60081) 2x 17W; 2x 32W (acc. to ANSI IEC C78.81)
Measures for light guidance	Standard: wide beam, internal reflector of the light fittings is painted in white colour. Colour: signal white RAL 9003; lateral glare reduction in the luminaire trough.

Ambient conditions

Ambient temperature	- 30 ... + 50 °C
	- 20 ... + 50 °C with Breathing Glands 8162
	- 5 ... + 40 °C operationable

Mechanical data

Degree of protection	IP66 / IP67 (IP64 when using the breather 8162) IEC 60598
Protection class	I (with internal PE connection)
Material	
Enclosure	
Enclosure	Polyester resin, glass fibre-reinforced
Colour	colour grey, similar to RAL 7035
Translucent cover	Polycarbonate
Gasket	Silicone foam gasket in the lamp cover
Luminaire locking	Central locking which can be opened/closed using a socket key M8 / wrench size 13, hinged lamp cover

Mounting / Installation

Cable glands	<p>Standard luminaire</p> <p>Plastic: 2 x M25 x 1.5 cable entries 8161 and 2 x M25 x 1.5 stopping plugs 8290 (enclosed)</p> <p>Metal: 2 x metal plates M20 x 1.5 connected by means of PE for metal cable entries Attention: cable entries must be ordered separately</p> <p>Special: max. 4 drilled holes for M20, M25, NPSM ½" max. 2 drilled holes for NPT ¾"</p> <p>Metal cable glands: M20 x 1.5, M25 x 1.5; earthing of the metal cable entries by means of metal plates</p>
Connection	<p>Standard: Spring clamp terminals 6-pole: L1, L2, L3, L', N, PE Clamping range: 1 x 0.75 ... 4 mm² (solid / finely stranded) (2 free clamping units per pole available)</p> <p>Special: Terminal block with covering 6-pole: L1, L2, L3, L', N, PE Clamping range: 2 x 1.5 ... 6 mm² (solid); 2 x 1.5 ... 4 mm² (finely and extra finely stranded)</p>
Through wiring	<p>Through wiring Standard luminaire luminaires are equipped with internal through wiring. Ingoing and outgoing leads can be connected to the opposite sides. Terminals: see techn. data Wiring cross section: 2.5 mm² for max. 16 A.</p> <p>without Optional On the connection side, there are 2 bores M25 x 1.5 for cable entries for ingoing and outgoing wiring of the connection line (ingoing and outgoing leads on one side).</p>
Assembly	<p>For outdoor mounting a breather is recommended</p> <p>Standard luminaire</p> <p>Standard: 2 x M8 insert nuts in the enclosure</p> <p>Special: Mounting grooves in the enclosure for use of fastening and ceiling rails for variable luminaire mounting (variable mounting distances for luminaires 17 W, 18 W: 320 ... 480 mm, 32 W, 36 W: 670 ... 930 mm)</p>

E2

Emergency Luminaire for Fluorescent Lamps

Series EXLUX 6009

Technical Data

Emergency light electronics

Emergency light mode	In the emergency light mode, only one lamp is used, which results in reduced light output		
Emergency light service time	Battery capacity	Emergency light service time	Emergency lighting power
	7 Ah	1.5 h	17 W; 18 W 32 W; 36 W
		3.0 h	100 % 60 % 30 %
Switchover voltage	from mains to battery operation for $U < 0.74 \times U_N$ from battery to mains operation for $U > 0.80 \times U_N$		

Battery set

Version	Gas-tight NiCd battery
Operating voltage	6 V
Capacity	7 Ah
Replacing the battery set	When opening the battery enclosure, the connection between the battery set and the emergency light electronics is disconnected. The battery set can be replaced after disconnecting the plug-in contacts.

Accessories and Spare Parts

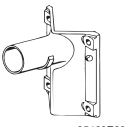
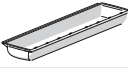
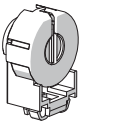
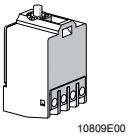
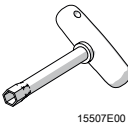
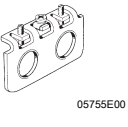
Designation	Figure	Description	Art. no.	Weight kg	
Fluorescent lamps	 04936E00	18 W 1350 lm	108952	0.100	
		36 W 3350 lm	108951	0.200	
		Two-pin cap \varnothing 26 mm Light colour: universal white Pins made of brass			
Bracket for wall mounting with tube	 05460E00	for side entry lamp; with tube, length 400 mm, \varnothing 42 mm	108947	2.480	
Lamp cover		for luminaire L=700	222427	0.639	
		for luminaire L=1310	222428	1.149	
Lamp-holder	 05696E00	Lamp holder G13	1 piece	117252	0.036
Switch	 10809E00	Switching element 8080/1-3-L, 2 normally closed contacts	132527	0.026	
Socket key	 15507E00	M8 / wrench size 13; to open/close the central locking	222430	0.210	
Adapter plates	 05755E00	1 x M20 x 1.5	1 piece	115815	0.070
		1 x M25 x 1.5	1 piece	115818	0.070
		2 x M20 x 1.5	1 piece	115826	0.058
		2 x M25 x 1.5	1 piece	115828	0.060
		for use together with metal cable glands; the metal cable glands are integrated in the earthing system via adapter plates			







Emergency Luminaire for Fluorescent Lamps

Series EXLUX 6009

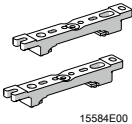
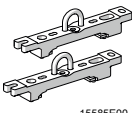

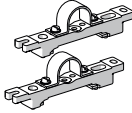
E2

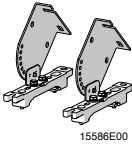
Accessories and Spare Parts

Designation	Figure	Description	Art. no.	Weight kg	
Mounting rail		for a variable mounting distance	1 pair	222826	0.300
Mounting bracket		mounting clamp mounted on a mounting rail for a variable mounting distance	1 pair	222456	0.400
Pole mounting sleeve		for the subsequent mounting on lights 18 W and 36 W, completely with assembly parts		227512	3.200
Pipe clamp		R 1 1/2"		222459	1.200
		R 1 1/4"		222458	1.250
		R 2"		222460	1.300
		with mounting rail for a variable mounting distance; Material: stainless steel	1 pair		
Ring bolt		M8, direct mounting in insert nuts	1 pair	115736	0.112
Breathing gland		M25 x 1.5 in order to avoid condensate formation		115738	0.017
Ceiling and wall-mounting bracket		mounted on a mounting rail for a variable mounting distance; Material: stainless steel Lamp can be swiveled in steps of 15°	1 pair	222827	2.400
Battery set for 6409		Battery cover with built-in battery. Gas-tight NiCd battery; 7 Ah / 6 V		223532	1.195

Dimensional Drawings (All Dimensions in mm [inches]) - Subject to Alterations

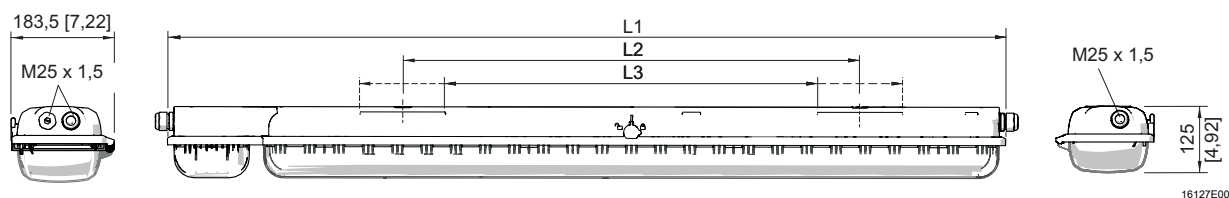

Dimensions	Luminaire	
	17/18 W	32/36 W
L1	857 [33.74]	1467 [57.76]
L2 ¹⁾	400 [15.75]	800 [31.50]
L3 ²⁾	320 ... 480 [12.60 ... 18.90]	670 ... 930 [26.38 ... 36.61]

¹⁾ fixed mounting distance
²⁾ variable mounting distance

EXLUX 6009

Emergency Luminaire for Fluorescent Lamps

Series EXLUX 6009

Dimensional Drawings for Assembly Parts and Accessories (All Dimensions in mm [inches]) - Subject to Alterations

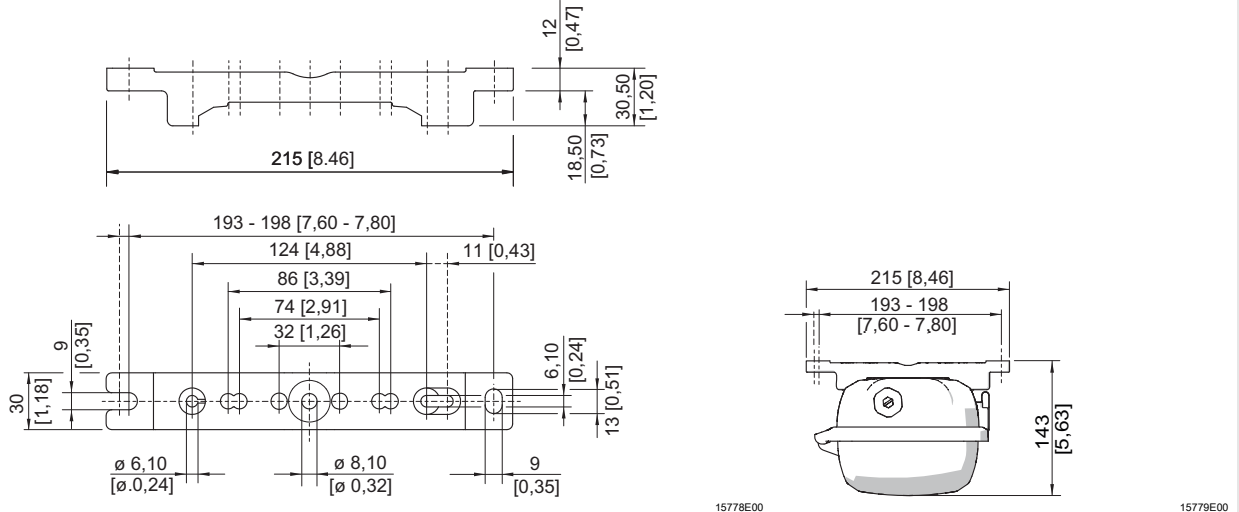

Mounting rail

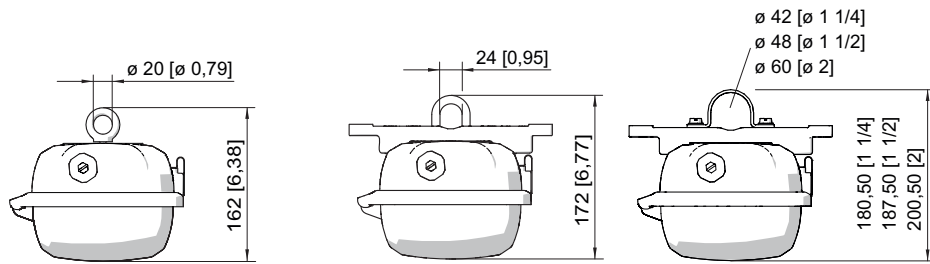

Ring bolt fitted in insert nut of the luminaire

Mounting bracket fitted in mounting rail

Pipe clamp fitted in mounting rail

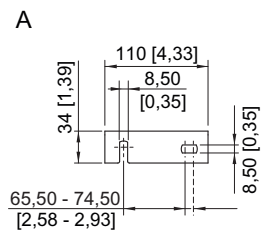
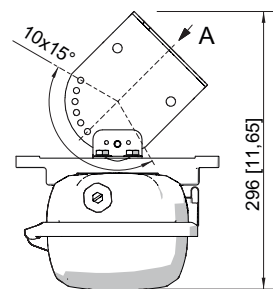

Wall mounting bracket fitted in mounting rail

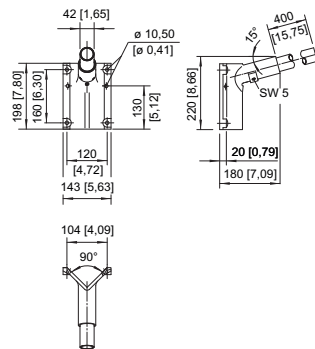

Bracket for wall mounting with pipe section

We reserve the right to make alterations to the technical data, dimensions, weights, designs and products available without notice. The illustrations cannot be considered binding.