

SOFTSTARTER TYPE PSTX

Fieldbus communication

Built-in Modbus RTU



PREPARED 2021-03-12	STATUS Approved	SECURITY LEVEL Public		
RELEASED 2021-05-03	DOCUMENT KIND Manual			
OWNING ORGANIZATION Motor Starting & Safety Softstarters	DOCUMENT ID. 1SFC132089M0201	REV. F	LANG. en	PAGE 1/36

Contents

- 1. Modbus RTU 3**
- 2. Modbus Addressing 4**
 - 2.1. Protocol Address 4
 - 2.2. Modicon Address 4
 - 2.3. Translating Modicon address to protocol address 5
- 3. PSTX Data 5**
 - 3.1. Digital input telegram 5
 - 3.2. Programmable Digital Inputs 6
 - 3.3. Analog input telegram 8
 - 3.4. Status word 8
 - 3.5. Programmable Analog Inputs 9
 - 3.6. Digital output telegram 11
 - 3.7. Analog output telegram 12
 - 3.8. Control words 13
- 4. Modbus RTU - A set-up example 14**
 - 4.1. Softstarter PSTX Modbus RTU communication 14
 - 4.2. Settings 14
 - 4.3. Read digital input telegram 16
 - 4.4. Write digital output telegram 17
 - 4.5. Read analog input telegram 18
 - 4.6. Write analog output telegram 19
- 5. Fieldbus Tasks 20**
 - 5.1. FBT Control Word 20
 - 5.2. Task ID 20
 - 5.3. Response ID 20
 - 5.4. Error codes 21
 - 5.5. Request parameter value, lower word 21
 - 5.5.1. Arguments 21
 - 5.5.2. Return Value 21
 - 5.6. Change parameter value 21
 - 5.6.1. Arguments 21
 - 5.6.2. Return Value 21
 - 5.7. Set date and time 22
 - 5.7.1. Arguments 22
 - 5.7.2. Return Value 22
 - 5.8. Request parameter value, upper word 22
 - 5.8.1. Arguments 22
 - 5.8.2. Return Value 22
 - 5.9. Parameter numbers and values 23
 - 5.9.1. Negative values 23
- 6. Troubleshooting 24**
- 7. Example application with Automation Builder 24**
 - 7.1. Create a new project in Automation Builder 24
 - 7.2. Add Modbus RTU master to project 26
 - 7.3. Build a START-STOP program 27
 - 7.4. Connect to PLC using TCP/IP 34
 - 7.5. Build and run the PLC demo program 36
- 8. Contact us 36**

STATUS	SECURITY LEVEL	DOCUMENT ID.	REV.	LANG.	PAGE
Approved	Public	1SFC132089M0201	F	en	2/36

1. Modbus RTU

Modbus is a master-slave protocol and only one device can transmit on the line at any time. The master (which in most cases is a PLC) manages the exchanges and only it can take the initiative. It interrogates each of the slaves in succession and no slave can send a message unless it is invited to do so. The master repeats the question when there is an incorrect exchange and declares the interrogated slave absent if no response is received within a given time. If a slave does not understand a message, it sends an exception response to the master who may or may not repeat the request.

The Modbus protocol is a fieldbus protocol that provides full control and status information of the softstarter, reading as well as writing of parameters. Through the fieldbus it is possible to start and stop the motor, read out currents and frequency, get information about protections, warnings, faults and much more.

See chapter 8 in the Installation and commissioning manual, document 1SFC132081M0201, for fieldbus related settings.

Before the Modbus RTU can be taken in operation following parameters must be set in the softstarter:

- Parameter 12.2 FB interface connector set to Modbus RTU.
- Parameter 12.3 Fieldbus control set to On (This parameter can be set to Off if the fieldbus interface is only used to monitor the softstarter)
- Parameter 12.9 FB baud rate set to a value matching existing Modbus network (supported baud rates are 9600, 19200, 38400, 57600, 76800 and 115200 Baud).
- Parameter 12.10 FB parity set to a value matching existing Modbus network.
- Parameter 12.11 FB stop bits set to a value matching existing Modbus network.
- Parameter 12.4 Fieldbus address set to an available Modbus slave id. In the examples (section 4) the fieldbus address is set to 47, but this parameter can be set to any value between 1-247.
- Parameter 12.1 Com3 function set to Modbus RTU slave.



Information

After changing any of the communication parameters it is needed to perform a power cycle of the device for the parameter values to be taken into effect. Or another way for a communication parameter value change to be taken into effect is to set parameter 12.2 FB interface connector to “None” and then set it back to “Modbus RTU”.

If there is no message passed between the PSTX softstarter and the Modbus master for more than the configured fieldbus failure timeout time (parameter 19.12), the PSTX softstarter will trip on fieldbus communication failure protection (P1E00) and with the default configuration the motor will be stopped. If the communication system is setup in such a way that commands/requests are not continuously passed between the PLC and softstarter, this protection function should be disabled. The parameter 19.4 (Fieldbus failure op) can then be set to “Off”.

STATUS	SECURITY LEVEL	DOCUMENT ID.	REV.	LANG.	PAGE
Approved	Public	1SFC132089M0201	F	en	3/36



Information

The DX111 or DX112 expansion IO module shares the same terminals (23 and 24) as the internal Modbus RTU communication, so both cannot be used at the same time.



Caution!

The motor may start unexpectedly if there is a start signal present when doing any of the actions listed below.

- Switching from one type of control to another (fieldbus control/hardwire control)
- Reset all Settings

2. Modbus Addressing

When talking about Modbus addressing, there is often a misunderstanding about what an address really is. This section will try to clarify the conventions in this document.

2.1. Protocol Address

The Modbus standard specification uses one kind of address, a two-byte unsigned integer (0-65535).

This is the address that is actually transmitted to the device.

2.2. Modicon Address

Modbus was originally developed by Modicon and the notation used then is still often used today, though considered obsolete by present standards.

The Modicon notation combines two pieces of information in a single number:

1. The register type
2. The register number

A register number offset defines the type and makes it possible to translate between the two types of addresses.

Table 1 Register types and ranges

Prefix	Register Type	Range
0x	Coil	00001-00001
1x	Discrete Input	10001-19999
3x	Input Register	30001-39999
4x	Holding Register	40001-49999

2.3. Translating Modicon address to protocol address

An example:

Modicon address 40002 selects the holding register at protocol address 0001 (40002 – 40001 = 1). The protocol address 0001 will be transmitted in the message packet.

3. PSTX Data

3.1. Digital input telegram

To PLC from the softstarter. The input data is updated every 20 ms.

Use Modbus function code 01, Read Coil Status.

Protocol Address	Modicon Address	Data	Description
0000h	00001	Auto Mode status ¹	0 = Softstarter control through Modbus disabled 1 = Softstarter control through Modbus enabled
0001h	00002	Event status	0 = No active fault/warning/protection 1 = Active fault/warning/protection
0002h	00003	Ready to start	0 = A start will probably cause a fault, 1 = A start will probably not cause a fault
0003h	00004	FBT Response 0	See Fieldbus Tasks
0004h	00005	FBT Response 1	See Fieldbus Tasks
0005h	00006	FBT Toggle Bit	See Fieldbus Tasks
0006h	00007	Programmable Digital Input 1	Function of programmable digital input, see section 3.2
0007h	00008	Programmable Digital Input 2	
0008h	00009	Programmable Digital Input 3	
0009h	00010	Programmable Digital Input 4	
000Ah	00011	Programmable Digital Input 5	
000Bh	00012	Programmable Digital Input 6	
000Ch	00013	Programmable Digital Input 7	
000Dh	00014	Programmable Digital Input 8	
000Eh	00015	Programmable Digital Input 9	
000Fh	00016	Programmable Digital Input 10	

¹⁾ Auto mode reflects the control state of the Softstarter. This is affected by a combination of:

- The Auto mode input signal from the PLC (protocol address 0000h in the digital output telegram or bit 3 in the control word).
- The state of the Local/Remote switch on the HMI.

- The parameter “Fieldbus control”.
- The digital input “Fieldbus disable”.

Digital input telegram is also available as a status word on protocol address 01FFh (see section 3.4).

3.2. Programmable Digital Inputs

The functions of the programmable Digital inputs are controlled by the parameters `Fieldbus DI 1` through `Fieldbus DI 10`. The following functions are available for selection:

Function	Data
None	Value is set to 0.
Start feedback	Status of Start signal.
Stop feedback	Status of Stop signal.
Fault reset feedback	Status of Reset signal.
Slow speed reverse feedback	Status of Slow speed reverse signal.
Slow speed forward feedback	Status of Slow speed forward signal.
Start 1 feedback	Status of Start 1 signal.
Start 2 feedback	Status of Start 2 signal.
Start 3 feedback	Status of Start 3 signal.
Motor heating feedback	Status Motor heating signal.
User defined feedback	Status of User defined protection signal.
Stand still brake feedback	Status of Stand still brake signal.
Emergency mode feedback	Status of Emergency mode signal.
Start reverse feedback	Status of Start reverse signal.
Run status	1 = Indicates when the softstarter gives voltage to the motor.
TOR status	Top of Ramp. 1 = Indicates that motor runs on full voltage.
Line	Line or Inside Delta Connection; 0 = Line, 1 = Delta.
Phase sequence	0 = L1, L2, L3; 1 = L1, L3, L2.
Event group 0 status	0 = No active events present in group 0.
Event group 1 status	0 = No active events present in group 1.
Event group 2 status	0 = No active events present in group 2.
Event group 3 status	0 = No active events present in group 3.
Event group 4 status	0 = No active events present in group 4.
Event group 5 status	0 = No active events present in group 5.
Event group 6 status	0 = No active events present in group 6.
Sequence 1 Run status	Run status of sequence connected motor 1.
Sequence 2 Run status	Run status of sequence connected motor 2.
Sequence 3 Run status	Run status of sequence connected motor 3.
Sequence 1 TOR status	Top of Ramp status of sequence connected motor 1.
Sequence 2 TOR status	Top of Ramp status of sequence connected motor 2.

Function	Data
Sequence 3 TOR status	Top of Ramp status of sequence connected motor 3.
Run reverse status	1 = Indicates when the softstarter gives voltage to the motor after a reverse start.
Enable status	Status of Enable signal.
Digital In0 status	Status of internal digital input In0.
Digital In1 status	Status of internal digital input In1.
Digital In2 status	Status of internal digital input In2.
Local control status	0 = Remote control, 1 = Local control (HMI).
Cancel brake feedback	Status of Cancel brake signal.
Pump cleaning auto status	Status of automatic pump cleaning.
Pump cleaning forward status	Status of forward pump cleaning.
Pump cleaning backward status	Status of reverse pump cleaning.
External digital 1DI0 status	Status of external digital input 1DI0 (not supported when using internal Modbus RTU).
External digital 1DI1 status	Status of external digital input 1DI1 (not supported when using internal Modbus RTU).
External digital 1DI2 status	Status of external digital input 1DI2 (not supported when using internal Modbus RTU).
External digital 1DI3 status	Status of external digital input 1DI3 (not supported when using internal Modbus RTU).
External digital 1DI4 status	Status of external digital input 1DI4 (not supported when using internal Modbus RTU).
External digital 2DI5 status	Status of external digital input 2DI5 (not supported when using internal Modbus RTU).
External digital 2DI6 status	Status of external digital input 2DI6 (not supported when using internal Modbus RTU).
External digital 2DI7 status	Status of external digital input 2DI7 (not supported when using internal Modbus RTU).
HW DI Start status	Status of the hard wire internal digital input Start.
HW DI Stop status	Status of the hard wire internal digital input Stop.
Ready to start (line contactor)	Same conditions as the Ready To Start bit except that the incoming three phase voltage condition is excluded. The bit can be used when a line contactor is connected.

3.3. Analog input telegram

To PLC from the softstarter.

All analog data values are represented as 16-bit values. The input data is updated every 20 ms.

Use Modbus function code 3 Read Holding Registers or function code 04, Read Input Registers.

Protocol Address	Modicon Address	Data	Representation
01FFh	30512	Status word	See section 3.4 Status word
0200h	30513	FBT Return Value	See Fieldbus Tasks
0201h	30514	Programmable Analog Input 1	Function of programmable analog input, see section 3.5
0202h	30515	Programmable Analog Input 2	
0203h	30516	Programmable Analog Input 3	
0204h	30517	Programmable Analog Input 4	
0205h	30518	Programmable Analog Input 5	
0206h	30519	Programmable Analog Input 6	
0207h	30520	Programmable Analog Input 7	
0208h	30521	Programmable Analog Input 8	
0209h	30522	Programmable Analog Input 9	
020Ah	30523	Programmable Analog Input 10	

3.4. Status word

The status word register is used to monitor the motor. This register can be used as an alternative to using the digital input telegram (section 3.1). Read status word using Modbus function code 3 Read Holding Registers or 4 Read Input Registers.

Protocol Address	Bit	Data	Description
01FFh	0	Auto Mode status ¹	0 = Softstarter control through Modbus disabled 1 = Softstarter control through Modbus enabled
	1	Event status	0 = No active fault/warning/protection 1 = Active fault/warning/protection
	2	Ready To Start	0 = A start will probably cause a fault, 1 = A start will probably not cause a fault
	3	FBT Response 0	See Fieldbus Tasks
	4	FBT Response 1	See Fieldbus Tasks
	5	FBT Toggle Bit	See Fieldbus Tasks
	6	Programmable Digital Input 1	Function of programmable digital input, see section 3.2
	7	Programmable Digital Input 2	
	8	Programmable Digital Input 3	
	9	Programmable Digital Input 4	

10	Programmable Digital Input 5
11	Programmable Digital Input 6
12	Programmable Digital Input 7
13	Programmable Digital Input 8
14	Programmable Digital Input 9
15	Programmable Digital Input 10

¹⁾ Auto mode reflects the control state of the Softstarter. This is affected by a combination of:

- The Auto mode input signal from the PLC ((protocol address 0000h in the digital output telegram or bit 3 in the control word).
- The state of the Local/Remote switch on the HMI.
- The parameter “Fieldbus control”.
- The digital input “Fieldbus disable”.

3.5. Programmable Analog Inputs

The functions of the programmable analog inputs are controlled by the parameters Fieldbus AI 1 through Fieldbus AI 10. The following functions are available for selection:

Function	Representation
None	Value is set to 0
Phase L1 current ¹	Value = 1000 ⇒ 100A
Phase L2 current ¹	Value = 1000 ⇒ 100A
Phase L3 current ¹	Value = 1000 ⇒ 100A
Active power (hp)	Value = 1000 ⇒ 10hp
Active power	Value = 1000 ⇒ 10kW
Apparent power	Value = 1000 ⇒ 10kVA
Mains voltage	Value = 1000 ⇒ 100V
Power factor	Value = 100 ⇒ 1 Example: 87 ⇒ 0.87
Motor voltage	Value = 100 ⇒ 100%
Active energy (resettable)	Value = 1000 ⇒ 10kWh
EOL time to trip	Value = 100 ⇒ 100s Value = 65535 ⇒ No overload Value = 0 ⇒ Trip already occurred
Mains frequency	Value = 1000 ⇒ 100Hz
Max phase current ¹	Value = 1000 ⇒ 100A
Motor current	Value = 1000 ⇒ 100A
Motor run time (resettable)	Value = 100 ⇒ 1000h
Motor temperature	Value = 100 ⇒ 100°C
Motor temperature percent	Value = 100 ⇒ 100%
Number of starts (resettable)	Value = 1 ⇒ 100

Function	Representation
Phase sequence	Value = 0 ⇒ L1->L2->L3 Value = 1 ⇒ L1->L3->L2 Value = 2 ⇒ No sequence detected
PT100 temperature	Value = n ⇒ n/10 – 50°C Example: 750 ⇒ 25°C
PTC resistance	Value = 100 ⇒ 100Ω
Reactive energy (resettable)	Value = 1000 ⇒ 10kVArh
Reactive power	Value = 1000 ⇒ 100VAr
Remaining time to start	Value = 100 ⇒ 100s
Thyristor temperature	Value = 100 ⇒ 100°C
Thyristor temperature percent	Value = 100 ⇒ 100%
EOL time to cool	Value = 100 ⇒ 100s
Top event code	Value = 1000 ⇒ 1000
Motor current in percent of IE.	Value = 100 ⇒ 100%
Thyristor run time (resettable)	Value = 1 ⇒ 10h
Motor connection	Value = 0 ⇒ auto Value = 1 ⇒ In-line Value = 2 ⇒ Inside delta – UI Value = 3 ⇒ Inside delta – IU Value = 4 ⇒ 2-phase L1 shorted Value = 5 ⇒ 2-phase L2 shorted Value = 6 ⇒ 2-phase L3 shorted
Phase L1 current high range ²	Value = 100 ⇒ 100A
Phase L2 current high range ²	Value = 100 ⇒ 100A
Phase L3 current high range ²	Value = 100 ⇒ 100A
Active power (hp) high range ²	Value = 100 ⇒ 100hp
Active power high range ²	Value = 100 ⇒ 100kW
Apparent power high range ²	Value = 100 ⇒ 100kVA
Reactive power high range ²	Value = 100 ⇒ 100kVAr
Max phase current high range ²	Value = 100 ⇒ 100A
Max motor current high range ²	Value = 100 ⇒ 100A
Active energy high range ²	Value = 1 ⇒ 10000kWh
Reactive energy high range ²	Value = 1 ⇒ 10000kVArh
Number of starts (high precision)	Value = 1 ⇒ 1

¹⁾ Phase current L1, L2 and L3 indicate the current through the softstarter, while the Max phase current is always the line current.

²⁾ High Range alternatives are available for a few signals where there is a possibility for the values to wrap. The values are 16-bit so the maximum value for each signal is 65535. The High Range alternatives have different scaling and will never wrap around but instead have lower precision.

3.6. Digital output telegram

From PLC to the softstarter.

Use Modbus function code 15 (0Fh), Force Multiple Coils.

Protocol Address	Modicon Address	Data	Description
0100h	257	Start	Commence a start when signal is set.
0101h	258	Stop	Commence a stop when signal is negated.
0102h	259	Fault reset	Reset signal for possible events.
0103h	260	Auto mode	This must be set for controlling the motor.
0104h	261	Slow speed reverse	Perform slow speed reverse when signal is set.
0105h	262	Slow speed forward	Perform slow speed when signal is set.
0106h	263	Spare	
0107h	264	Start1	Start1 if sequence start.
0108h	265	Start2	Start2 if sequence start.
0109h	266	Start3	Start3 if sequence start.
010Ah	267	Motor heating	Perform motor heating when signal is set.
010Bh	268	Stand still brake	Perform stand still brake when signal is set.
010Ch	269	Start reverse	Commence a reverse start when signal is set.
010Dh	270	Spare	
010Eh	271	Emergency mode	Set to "1" to enable emergency mode.
010Fh	272	FBT Toggle Bit	See Fieldbus Tasks.
0110h	273	User defined trip	Set to "1" to trigger user defined protection.
0111h	274	Switch to remote control	Switch to remote control when signal is set (rising edge triggered).
0112h	275	Pump cleaning auto-matic	Perform automatic pump cleaning when signal is set.
0113h	276	Pump cleaning forward	Perform forward pump cleaning when signal is set.
0114h	277	Pump cleaning reverse	Perform reverse pump cleaning when signal is set.
0115h	278	K4 relay command	Set "1" to activate the internal K4 output relay. Note that parameter 10.4 K4 function has to be set as "Fieldbus"
0116h	279	K5 relay command	Set "1" to activate the internal K5 output relay. Note that parameter 10.5 K5 function has to be set as "Fieldbus"
0117h	280	K6 relay command	Set "1" to activate the internal K6 output relay. Note that parameter 10.6 K6 function has to be set as "Fieldbus"
0118h	281	1DO0 relay command	Set "1" to activate the external 1DO0 output relay. Note that parameter 11.9 1DO0 function has to be set as "Fieldbus"

Protocol Address	Modicon Address	Data	Description
0119h	282	1DO1 relay command	Set "1" to activate the external 1DO1 output relay. Note that parameter 11.10 1DO1 function has to be set as "Fieldbus"
011Ah	283	2DO2 relay command	Set "1" to activate the external 2DO2 output relay. Note that parameter 11.11 2DO2 function has to be set as "Fieldbus"
011Bh	284	2DO3 relay command	Set "1" to activate the external 2DO3 output relay. Note that parameter 11.12 2DO3 function has to be set as "Fieldbus"
011Ch	285	Refresh parameters	Restart fieldbus interface to refresh communication parameters
011Dh	286	Spare	
011Eh	287	Spare	
011Fh	288	Spare	

Digital output telegram is also available as a control words on protocol addresses 02FEh and 02FFh (see section 3.8).

3.7. Analog output telegram

From PLC to the softstarter.

All analog data values are represented as 16-bit values.

Use Modbus function code 6 Write Single Register or 16 (10h) Write Multiple Registers.

Protocol Address	Modicon Address	Data	Representation
02FEh	40767	Control word 1	See section 3.8 Control words
02FFh	40768	Control word 2	See section 3.8 Control words
0300h	40769	FBT Control Word	This register is used to read parameters (see fieldbus tasks).
0301h	40770	Fieldbus AO 1 (FBT Argument 2 or Internal analog output)	Parameter 12.37 Fieldbus AO1 decides the use of this register. If set as "FBT Argument 2", it is used to write parameters and set time (see fieldbus tasks). If set as "Internal analog output" this value of this register controls the internal analog output. Note that parameter 10.8 AO type needs to be set as "Fieldbus [%]".
0302h	40771	Fieldbus AO 2 (FBT Argument 3 or External analog output)	Parameter 12.38 Fieldbus AO2 decides the use of this register. If set as "FBT Argument 3", it is used to write parameters and set time (see fieldbus tasks). If set as "External analog output" this value of this register controls the external analog output. Note that parameter 11.14 1AO0 type needs to be set as "Fieldbus [%]".

3.8. Control words

The control word registers are used to control the motor. These registers can be used as an alternative to using the digital output telegram (section 3.6).

Write control word using Modbus function code 6 Write Single Register or 16 (10h) Write Multiple Registers.

Protocol Address	Bit	Data	Description
02FEh	0	Start	Commence a start when signal is set.
	1	Stop	Commence a stop when signal is negated.
	2	Fault reset	Reset signal for possible events.
	3	Auto mode	This must be set for controlling the motor.
	4	Slow speed reverse	Perform slow speed reverse when signal is set.
	5	Slow speed forward	Perform slow speed when signal is set.
	6	Spare	
	7	Start1	Start1 if sequence start.
	8	Start2	Start2 if sequence start.
	9	Start3	Start3 if sequence start.
	10	Motor heating	Perform motor heating when signal is set.
	11	Stand still brake	Perform stand still brake when signal is set.
	12	Start reverse	Commence a reverse start when signal is set.
	13	Spare	
	14	Emergency mode	Set to "1" to enable emergency mode.
15	FBT Toggle Bit	See Fieldbus Tasks.	
02FFh	0	User defined trip	Set to "1" to trigger user defined protection.
	1	Switch to remote control	Switch to remote control when signal is set (rising edge triggered).
	2	Pump cleaning automatic	Perform automatic pump cleaning when signal is set.
	3	Pump cleaning forward	Perform forward pump cleaning when signal is set.
	4	Pump cleaning reverse	Perform reverse pump cleaning when signal is set.
	5	K4 relay command	Set "1" to activate the internal K4 output relay. Note that parameter 10.4 K4 function has to be set as "Fieldbus"
	6	K5 relay command	Set "1" to activate the internal K5 output relay. Note that parameter 10.5 K5 function has to be set as "Fieldbus"
7	K6 relay command	Set "1" to activate the internal K6 output relay. Note that parameter 10.6 K6 function has to be set as "Fieldbus"	

8	1DO0 relay command	Set "1" to activate the external 1DO0 output relay. Note that parameter 11.9 1DO0 function has to be set as "Fieldbus"
9	1DO1 relay command	Set "1" to activate the external 1DO1 output relay. Note that parameter 11.10 1DO1 function has to be set as "Fieldbus"
10	2DO2 relay command	Set "1" to activate the external 2DO2 output relay. Note that parameter 11.11 2DO2 function has to be set as "Fieldbus"
11	2DO3 relay command	Set "1" to activate the external 2DO3 output relay. Note that parameter 11.12 2DO3 function has to be set as "Fieldbus"
12	Refresh parameters	Automatic restart of fieldbus driver to refresh parameters
13	Spare	
14	Spare	
15	Spare	

It is recommended to give the start/stop commands to the Softstarter using bit 0, 1 in the control word 1 or protocol address 0100h, 0101h. Which of these registers that will be acknowledged by the device depends on the auto mode configuration.

If auto mode is set using protocol address 0103h, then the start/stop commands can be given using protocol address 0100h, 0101h. But if bit 3 in the control word 1 (protocol address 02FEh) is set, then the start/stop commands can be given using bit 0, 1 in the control word 1.

However, if auto mode is set in both protocol address 0103h and bit 3 in the control word 1, then start/stop commands will not be acknowledged by the device due to incorrect configuration.

Fault reset, FBT Toggle Bit, Switch to remote control, K4 relay command, K5 relay command, and K6 relay command can be done from both the digital output telegram and the control words even when auto mode is not enabled.

4. Modbus RTU - A set-up example

4.1. Softstarter PSTX Modbus RTU communication

This document describes an application example between a Modbus RTU master (PLC CPU, PC, etc.) and the ABB softstarter PSTX using the built-in Modbus RTU interface.

Please always use the actual softstarter manuals. In this particular example following documents has been used:

- Softstarter PSTX Installation and commissioning manual, document 1SFC132081M0201

4.2. Settings

1. Set the softstarter address and field bus communication

Change the address of the softstarter to 47 (Fieldbus Address) and enable fieldbus control (Fieldbus control = On).

STATUS	SECURITY LEVEL	DOCUMENT ID.	REV.	LANG.	PAGE
Approved	Public	1SFC132089M0201	F	en	14/36

2. **Set the communication parameters**

Change the communication parameters baud rate, parity, stop bits to match the Modbus network settings.

3. **Select Com3 function**

Change parameter Com3 function to Modbus RTU Slave to make the Modbus RTU interface available.

4. **Select the Modbus RTU interface**

The previous changes are taken in effect when the fieldbus interface is changed. Change parameter FB interface connector to Modbus RTU.

STATUS	SECURITY LEVEL	DOCUMENT ID.	REV.	LANG.	PAGE
Approved	Public	1SFC132089M0201	F	en	15/36

4.3. Read digital input telegram

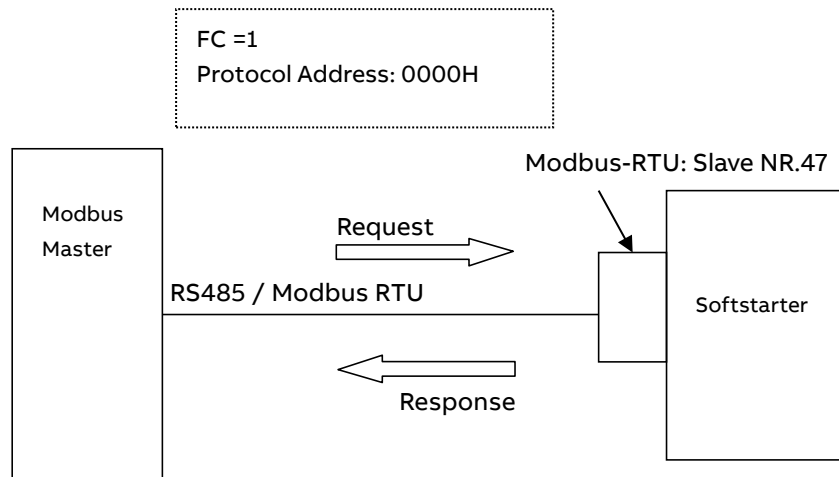

E.g.: Read 16 bit starting at the address: 0000H

Request:

2F 01 00 00 00 10 3B 88



Slave 47	FC = 01	Address	16 bit	CRC
----------	---------	---------	--------	-----

Response:

2F 01 02 00 00 51 FA



Slave 47	FC = 01	0 Byte	1 Byte	2 Byte	CRC
----------	---------	--------	--------	--------	-----

4.4. Write digital output telegram

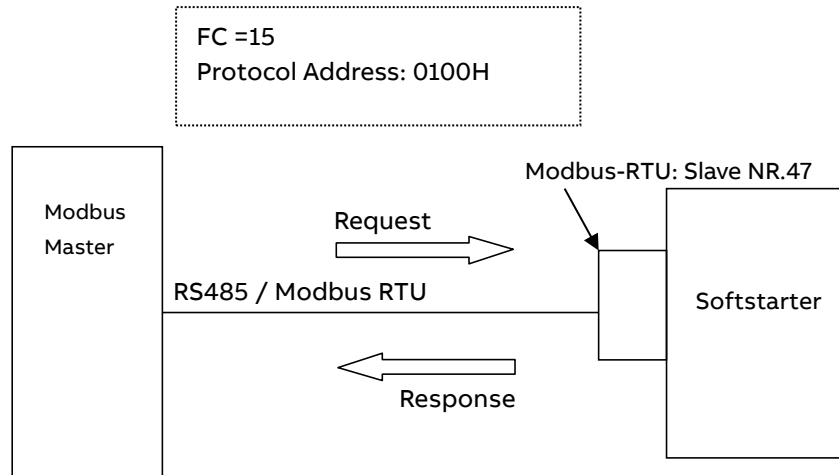

E.g.: Write 16 bit starting at the address: 0100H

Request:

2F 0F 01 00 00 10 02 00 00 27 41



Slave 47
 FC = 15
 Address
 16 bit
 2 byte
 Output
 CRC

Response:

2F 0F 01 00 00 10 53 B5



Slave 47
 FC = 15
 Address
 16 bit
 CRC

4.5. Read analog input telegram

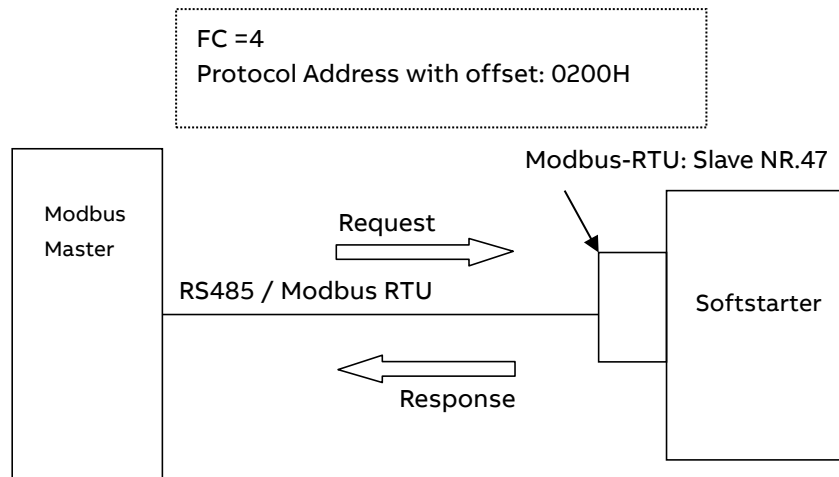

E.g.: Read analog output words 2 & 3. Phase L1 current and Phase L2 current with default settings.

Request:

2F 04 02 01 00 02 27 FD

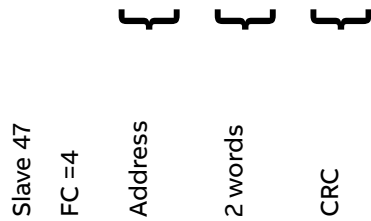

Response:

2F 04 04 00 00 00 00 35 86

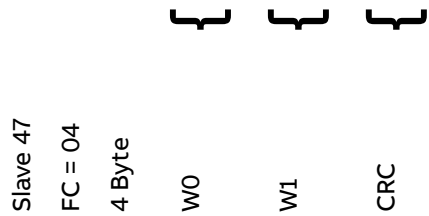

W0: Phase L1 current

W1: Phase L2 current

4.6. Write analog output telegram

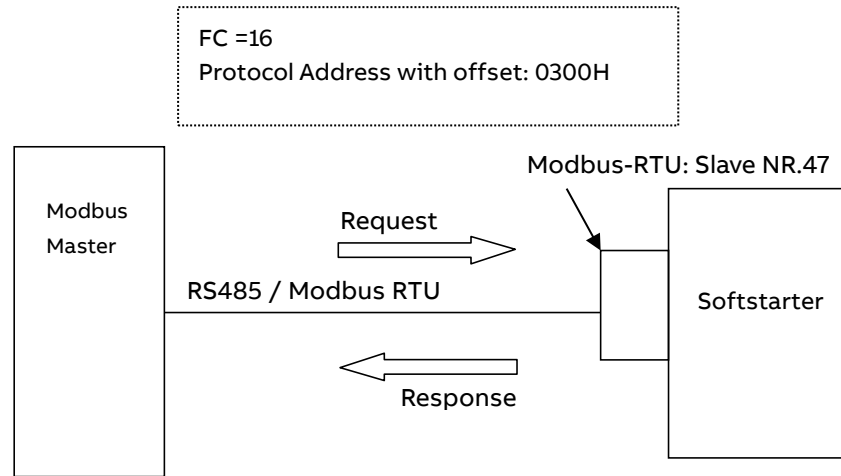

E.g.: Write analog output words 1 & 2. FBT Control Word and FBT Argument 2.

Request:

2F 10 03 00 00 02 04 00 00 00 00 78 77



Slave 47	FC = 16	Address	2 Words	4 Byte	W0	W1	CRC
----------	---------	---------	---------	--------	----	----	-----

Response:

2F 10 03 00 00 02 47 C2



Slave 47	FC =16	Address	2 words	CRC
----------	--------	---------	---------	-----

W0: FBT Control Word

W1: FBT Argument 2

5. Fieldbus Tasks

By using Fieldbus Tasks it is possible to read/write parameters and set the real-time clock.

Which task to execute is selected by filling in the FBT Control Word. There are three signals for arguments to the task:

- FBT Argument 1 is packed together with the Task ID in the FBT Control Word.
- There are two additional 16-bit arguments in separate analog output signals, FBT Argument 2 and FBT Argument 3.

To control when the task is executed, the digital output signal FBT Toggle Bit shall be changed. The softstarter will detect the change, execute the task, fill in the return values, and toggle the digital input signal FBT Toggle Bit as acknowledgement. Thus, the return values must be disregarded if the two toggle bits have different value.

5.1. FBT Control Word

The control word is a 16-bit analog output value sent from the PLC to the softstarter. It consists of a Task ID and an 11-bit argument packed together.

15	14, 13, 12,	11	10, 9, 8, 7, 6, 5, 4, 3, 2, 1, 0
-	Task ID	-	Argument 1

5.2. Task ID

The task identifier controls which function should be performed.

Task ID	Task	Response ID	
		Positive	Negative
0	No task	0	-
1	Request parameter value, lower word	1	2
2	Change parameter value	1	2
3	Set date and time	1	2
4	Request parameter value, upper word	1	2

5.3. Response ID

The response ID is the softstarter response to a task. It tells whether a task was executed successfully. If there was an error, an additional error code is returned in the FBT Return Value analog input. The Response ID is transmitted as two digital input signals, FBT Response 0 and FBT Response 1.

Response ID	FBT Response 1	FBT Response 0	Explanation
0	0	0	No response
1	0	1	Task executed
2	1	0	Task cannot be executed (with error number)
3	1	1	Reserved.

5.4. Error codes

The following error codes are sent when a task cannot be executed.

Error code	Explanation
0	Illegal parameter number
1	Parameter value cannot be changed
3	Lower or upper limit violated
4	Invalid argument
5	No error
6	Invalid task number

5.5. Request parameter value, lower word

This task reads the lower 16 bits of the specified parameter. See chapter 5.9 for parameter number and value scaling information.

5.5.1. Arguments

- FBT Argument 1: parameter number.

5.5.2. Return Value

- Response ID 1 and parameter value in FBT Return Value on success.
- Response ID 2 and error number in FBT Return Value on failure.

5.6. Change parameter value

This task writes a specified value to a parameter. See chapter 5.9 for parameter number and value scaling information.

5.6.1. Arguments

- FBT Argument 1: parameter number.
- FBT Argument 2: parameter value (lower word)
- FBT Argument 3: parameter value (upper word)

5.6.2. Return Value

- Response ID 1 on success.
- Response ID 2 and error number in FBT Return Value on failure.

5.7. Set date and time

This task updates the real-time clock on the softstarter. The date and time fields have the following limits:

- Year: 0-63 (2000-2063)
- Month: 1-12
- Day: 1-31
- Hour: 0-23
- Minute: 0-59
- Second: 0-59

5.7.1. Arguments

- FBT Argument 2: year, month, day and least significant bit of seconds

15	14, 13, 12, 11, 10, 9	8, 7, 6, 5	4, 3, 2, 1, 0
s0	year	month	day

- FBT Argument 3: hour, minute, seconds, bit 1-5

15, 14, 13, 12, 11	10, 9, 8, 7, 6, 5	4, 3, 2, 1, 0
Hour	minute	seconds, bit 1-5

5.7.2. Return Value

- Response ID 1 on success.
- Response ID 2 and error number in FBT Return Value on failure. In case the supplied time didn't differ from the set time, error code 5 (no error) is used.

5.8. Request parameter value, upper word

This task reads the upper 16 bits of the specified parameter. See chapter 5.9 for parameter number and value scaling information.

5.8.1. Arguments

- FBT Argument 1: parameter number.

5.8.2. Return Value

- Response ID 1 and parameter value in FBT Return Value on success.
- Response ID 2 and error number in FBT Return Value on failure.

5.9. Parameter numbers and values

To access parameters from the fieldbus a unique parameter number is needed, this can be found in document 1SFC132081M0201, Chapter 7.25 Complete parameter list.

Since the parameter values need to be represented as integers on the fieldbus while, the parameter values with greater precision need to be scaled. In document 1SFC132081M0201, Chapter 7.25 Complete parameter list, there is a column specifying the number of decimals for each parameter.

Parameter values that are read from the fieldbus needs to be divided by $10^{\text{number of decimals}}$.

Parameters values that are written from the fieldbus needs to be multiplied by $10^{\text{number of decimals}}$.

For example:

The parameter Kick start time has parameter number 24 and 2 decimals. To read this parameter:

1. Set FBT Task ID to 1.
2. Set FBT Argument 1 to 24 to specify the parameter.
3. Toggle FBT Toggle Bit output and wait for the FBT Toggle Bit input to update.
4. Response ID 1 should now contain value 1, indicating success.
5. FBT Return Value contains the value 50 (this is an example and depends on the actual set value).
6. The return value should be interpreted as $50/10^2 = 0.5s$.

To change the Kick start time parameter to 1s:

1. Set FBT Task ID to 2.
2. Set FBT Argument 1 to 24.
3. Set FBT Argument 2 to $1 \cdot 10^2 = 100$.
4. Set FBT Argument 3 to 0 as $100 \leq 65535$ which means it doesn't require more than 16 bits.
5. Toggle FBT Toggle Bit output and wait for the FBT Toggle Bit input to update.
6. Response ID 1 should now contain value 1, indicating success.

5.9.1. Negative values

Negative values are represented internally using 32-bit two's complement numbers.

Example:

Setting parameter 17.5 PT100 reset temp (parameter number 249) to a value of -25°C:

The two's complement of -25 is FFFFFFFE_{hex}. The upper word is FFFF_{hex} and the lower FFE7_{hex}, in decimal notation 65535 and 65511.

1. Set FBT Task ID to 2 for Change parameter value.
2. Set FBT Argument 1 to 249 to specify the parameter.
3. Set FBT Argument 2 to 65511 to specify the lower word.
4. Set FBT Argument 3 to 65535 to specify the upper word.
5. Toggle FBT Toggle Bit output and wait for the FBT Toggle Bit input to update.
6. Response ID 1 should now contain value 1, indicating success.

STATUS	SECURITY LEVEL	DOCUMENT ID.	REV.	LANG.	PAGE
Approved	Public	1SFC132089M0201	F	en	23/36

6. Troubleshooting

RS485

- Are the termination resistors placed at the end of the line?
- Only 2 termination resistors in one segment?
- Are 2 termination resistors placed at each bus segment?
- Are bias resistors connected in each bus segment?
- Is the line polarity correct? Are the lines by accident swapped?
- Never place any termination resistors on a drop cable.
- Is the maximum line length exceeded?

Modbus slave

- Has the device a unique Modbus address?
- Is the function code supported by the device?
- Has the request a valid address?
- Has the request a valid quantity of coils, inputs, registers?
- Is the power supply turned on?

Modbus master

- Is the Modbus master in RTU mode?
- Is the request to response timeout correct?
- Is the Modbus master silent interval between two telegrams > 3.5 character times?
- Notice that the slave device will not give any response when it is addressed with a broadcast (slave address = 0).
- Check if PLC is in run mode.

7. Example application with Automation Builder

This section shows a demo about how to start and stop motor by sending commands from fieldbus that is controlled by Programmable logic controller (PLC). We use Automation Builder as an example platform and show the demo about building such communication setting.

7.1. Create a new project in Automation Builder

We perform the following steps in Automation Builder 2.1 for PLC AC500 PM573.

1. Open Automation Builder

2. Select File->New Project->AC500 project->OK

STATUS	SECURITY LEVEL	DOCUMENT ID.	REV.	LANG.	PAGE
Approved	Public	1SFC132089M0201	F	en	24/36

3. Select the correct PLC CPU in Search object name ...-> Add PLC.

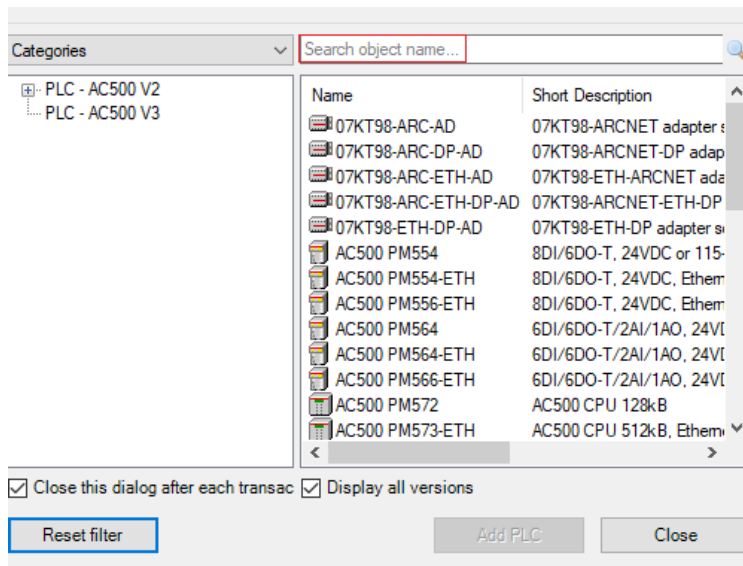

4. Check that the correct device type is selected by double clicking the device name in Devices field. Check that the correct Terminal Base Type is also selected for the tag for Hardware.

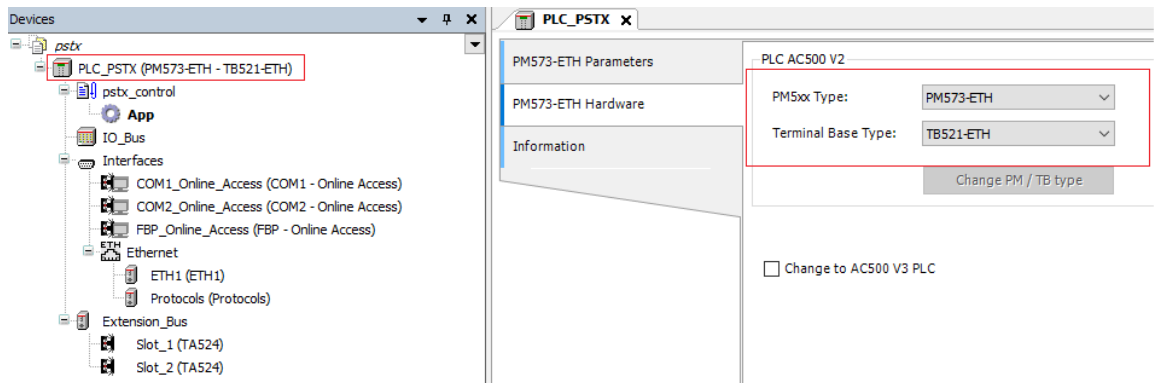

7.2. Add Modbus RTU master to project

1. Right click on one of the COM ports and select Add object

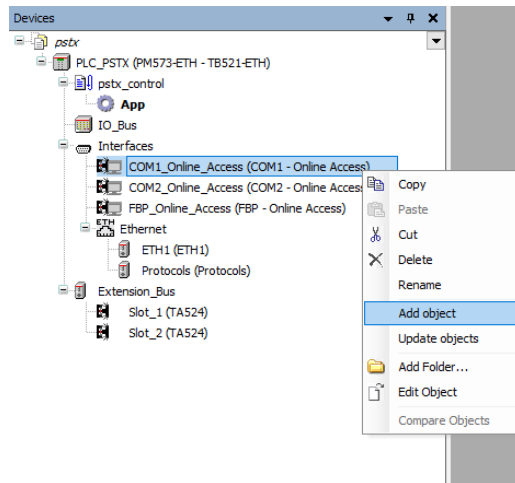

2. Select COM1 - Modbus and click Replace object

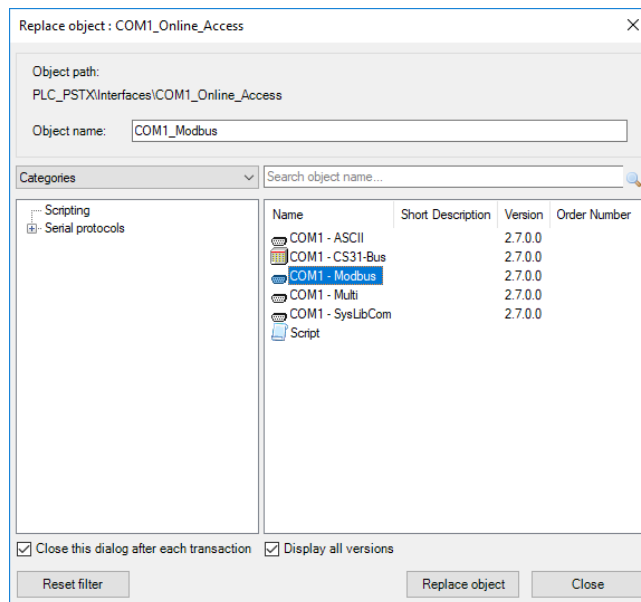

3. Double click interfaces, COM1_Modbus, from the device tree. Set RTS control to Telegram and Operation mode to Client for COM1 – Modbus Parameters in COM1_Modbus

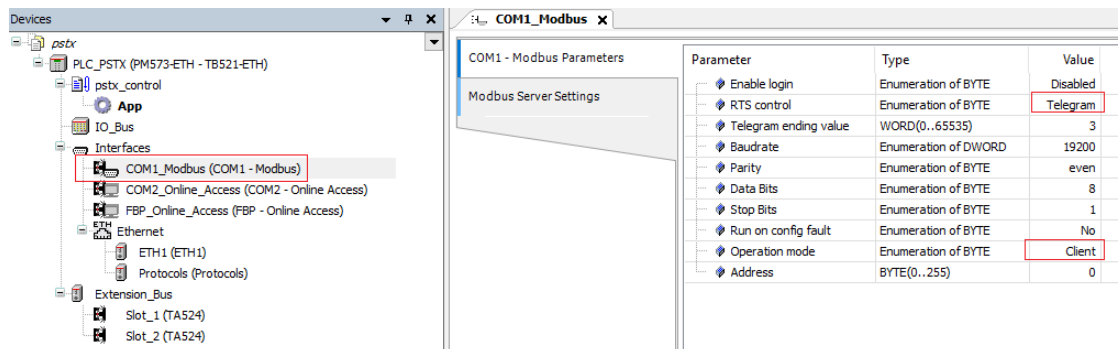

7.3. Build a START-STOP program

We perform the following steps for building our start-stop demo program in CoDeSys.

1. Open CoDeSys by double clicking your application in Devices file in Automation Builder, if it is not opened yet.

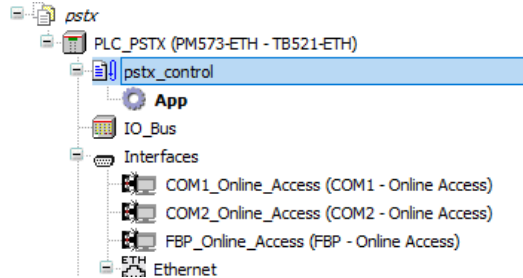

2. Delete the default POU by right click on it and select

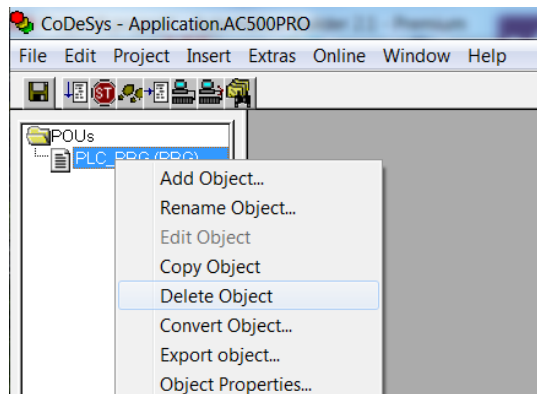

3. We choose to use LD as the language of the POU here by right click POU's -> Add Object... -> Insert Name of the new POU -> Choose "LD" for "Language of the POU" -> OK

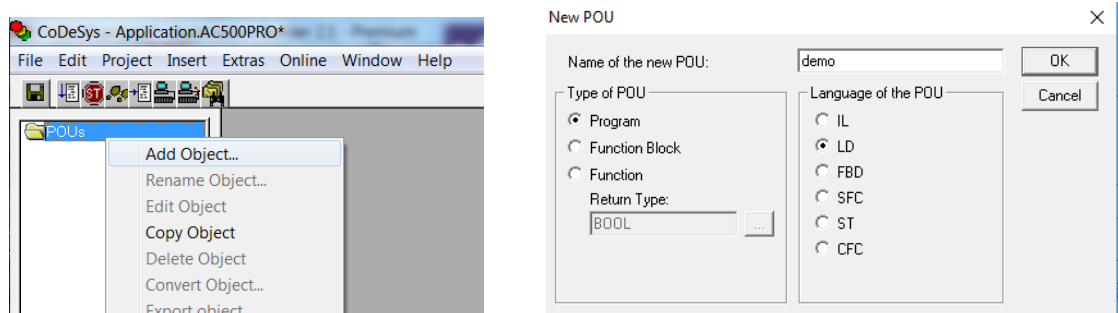

- Open the newly created POU by double click it and select the first network, create a contact (by CTRL+K) and two coils (by CTRL+L)

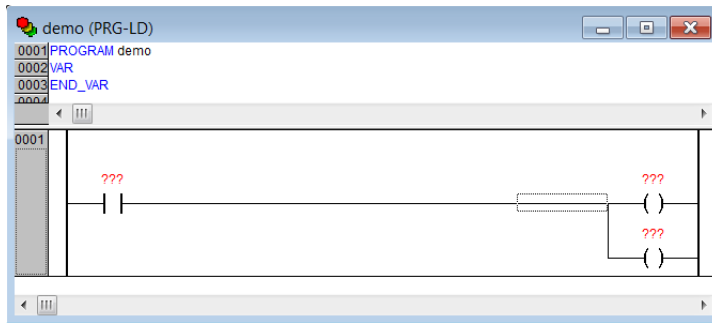

- Name the contact START by changing the ??? to START, select type BOOL

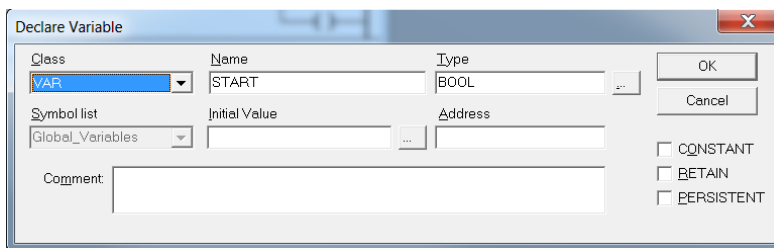

- Name the coils "BITVAL[1]" and "BITVAL[2]", set the type to "ARRAY [1..16] OF BOOL"

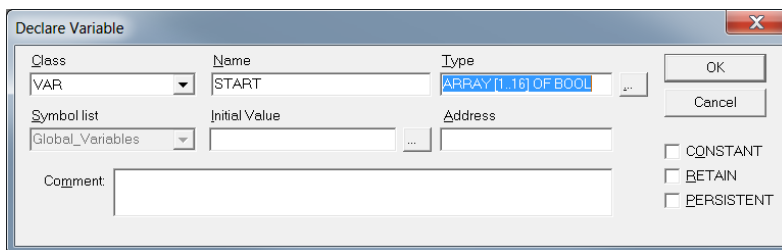

- Add a second network by CTRL+T and add a single coil (by CTRL+L) named "BITVAL[4]"

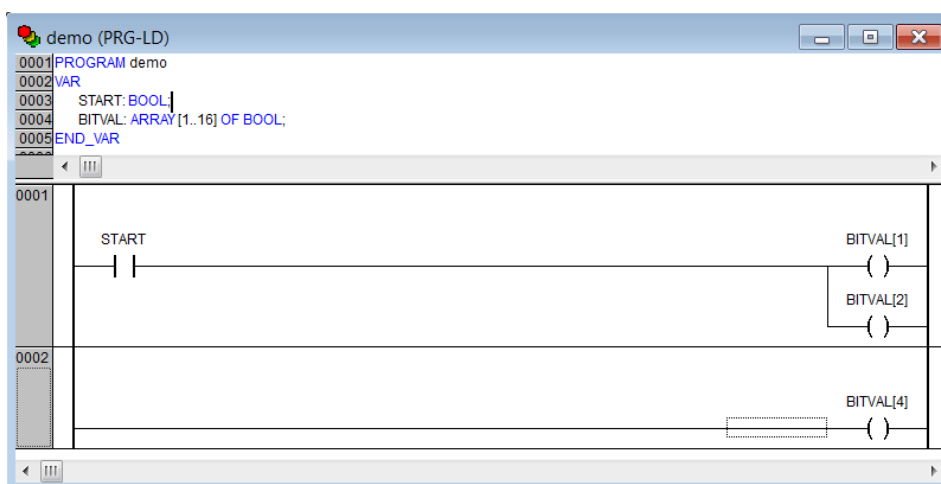

8. Add another network by CTRL+T. Create a function block “BLINK” by CTRL+B and select Standard Function Blocks -> Util.lib -> signals-> BLINK(FB)->Ok.

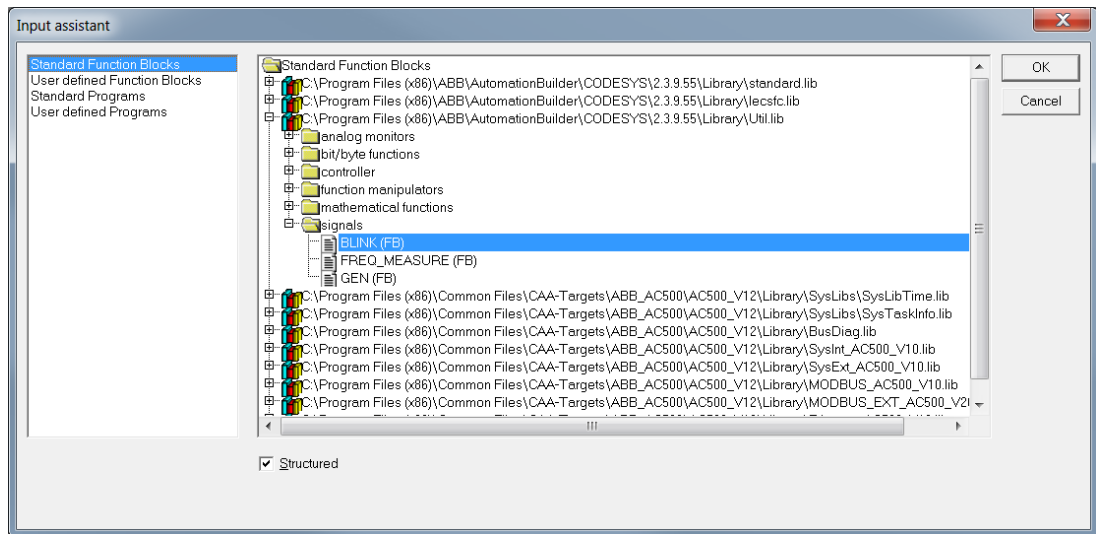

9. We name the BLINK function block as blink. We set t#2ms for TIMELOW and TIMEHIGH.

10. Continue to create a function block “COM_MOD_MAST” by CTRL+B and select Standard Function Blocks -> MODBUS_AC500_V10.LIB -> COM_MOD_MAST(FB) -> OK.

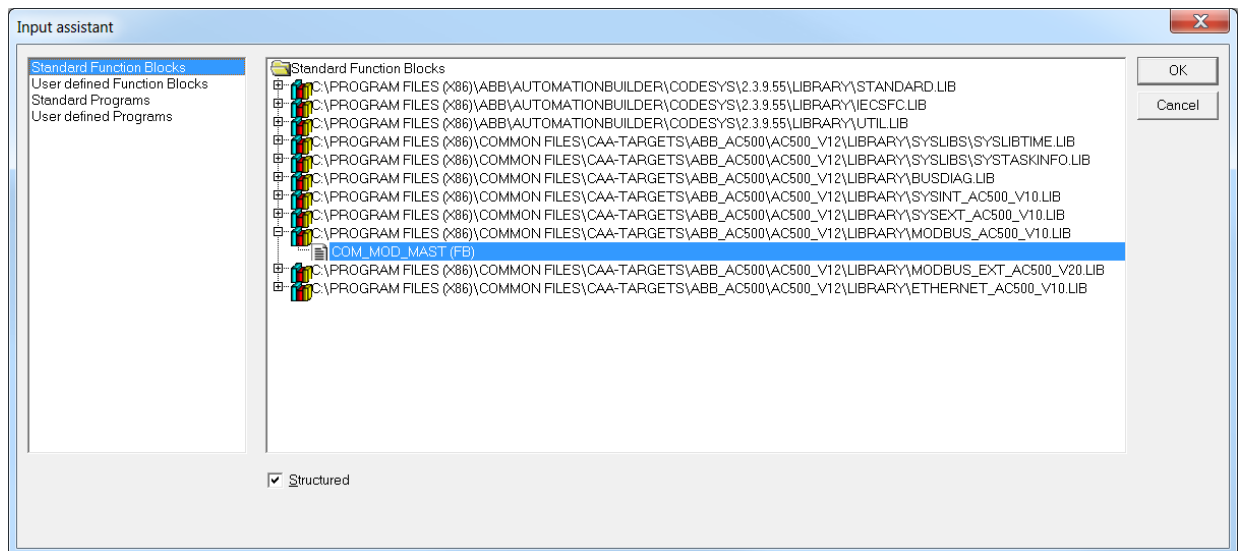

STATUS	SECURITY LEVEL	DOCUMENT ID.	REV.	LANG.	PAGE
Approved	Public	1SFC132089M0201	F	en	29/36

Now, we should have two function blocks in network 0003.

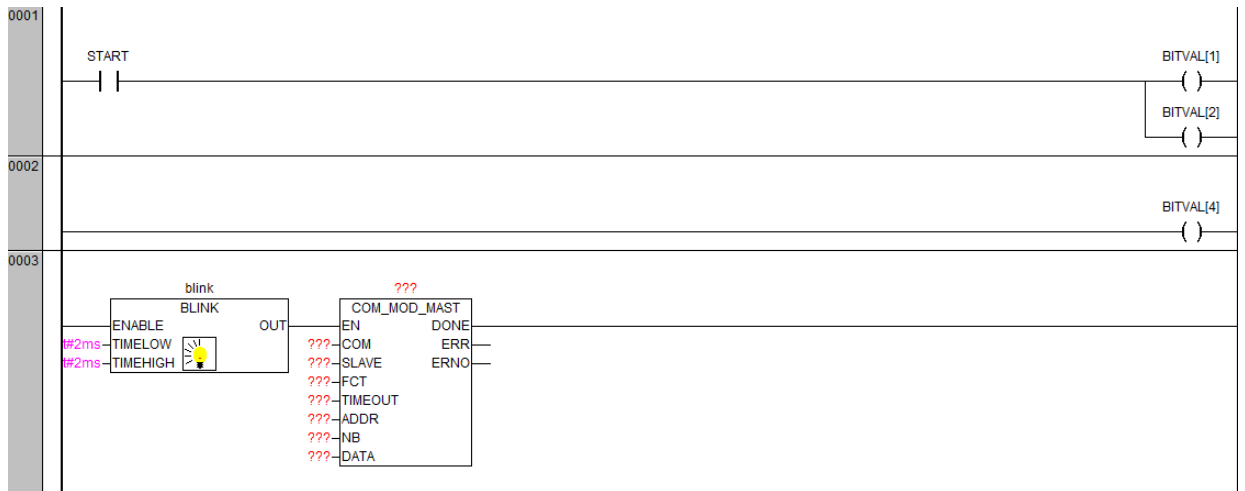

The COM_MOD_MAST is a function block for sending/receiving OpenModbus. Their definition is available from CoDeSys -> Resources -> Library Manager.

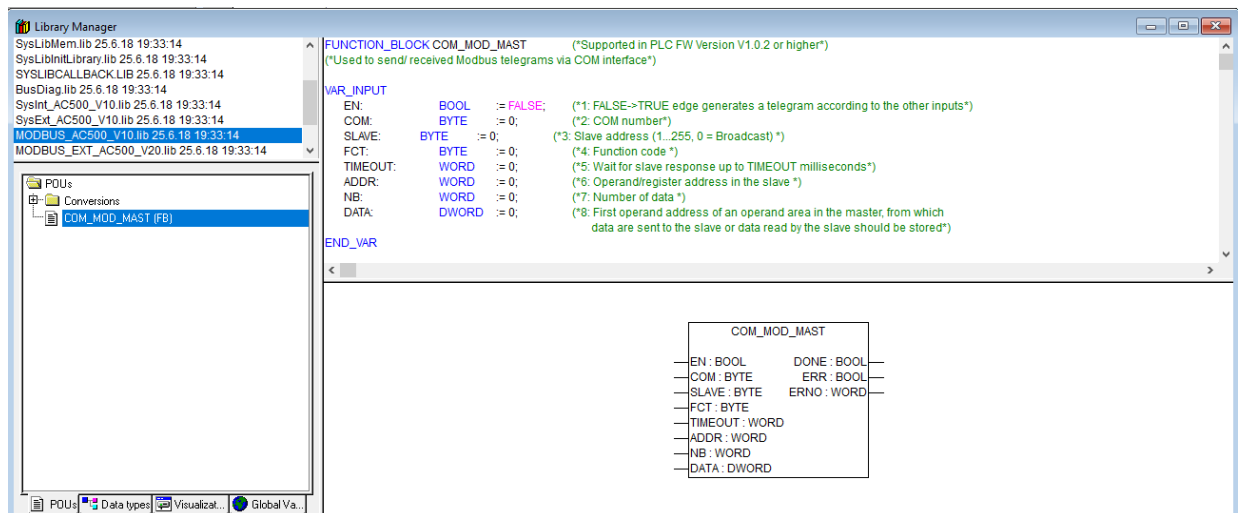

To enable this function block, it is required to send a FALSE->TRUE edge at input EN and therefore we introduce BLINK, which is for creating a flip-flop signal.

11. DATA (the data to send) require DWORD inputs. We can convert data with a box, "ADR".

- a) Select the bar in front of DATA

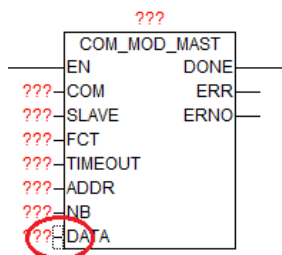

b) Choose Insert-> Insert at Blocks-> Box

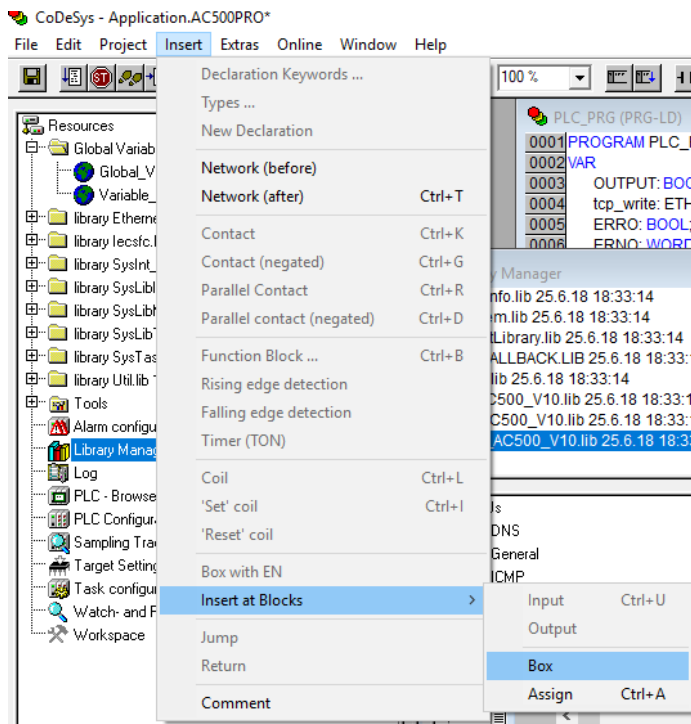

The default box is “AND”, change the name to ADR and it will be an ADR box.

12. Set:

- The name of the block to modbus_write
- COM to 1 or 2 depending on comport used
- Slave to the value of “Fieldbus address” (Parameter 12.4 in PSTX)
- FCT to 15
- TIMEOUT to 100
- ADDR to 256, according to Section 3.6, the first Protocol Address is 0100h.
- NB to 16
- ERR to ERRO (new BOOL variable)
- ERRNO (new WORD variable)

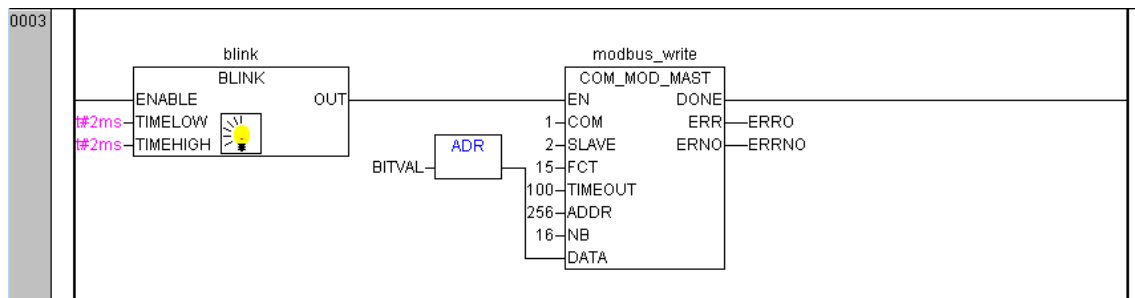

13. Insert a coil named "OUTPUT" in the last network and the LD-program is done.

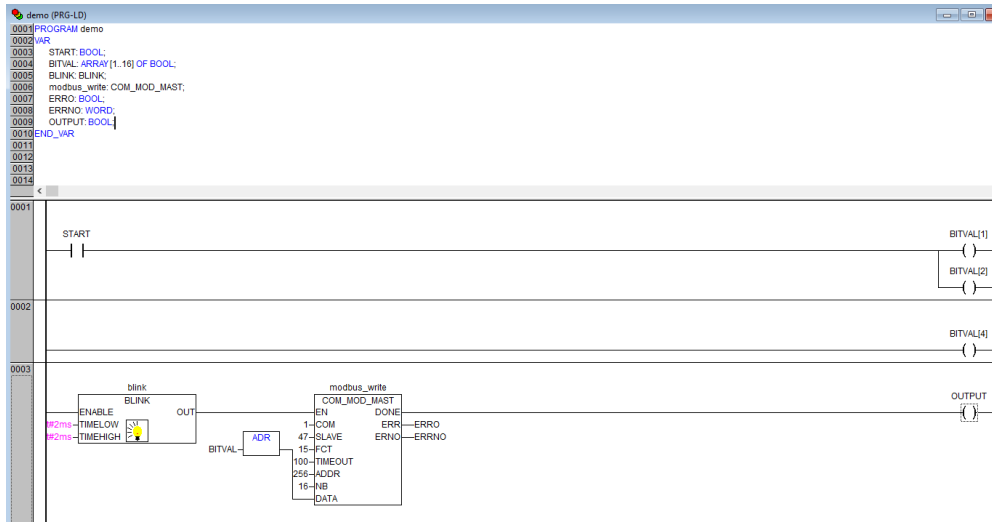

14. Now we want to create one control button for signing the value of "START" from the first network into TRUE. We do this by Visualization -> right click -> Add object -> Write name of the new Visualization as "view" -> OK.

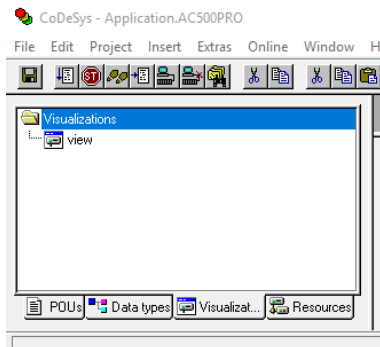

15. We draw a shape as the button  -> double click the shape -> Regular Element Configuration -> Input -> check Toggle variable -> insert "demo.START" -> OK.

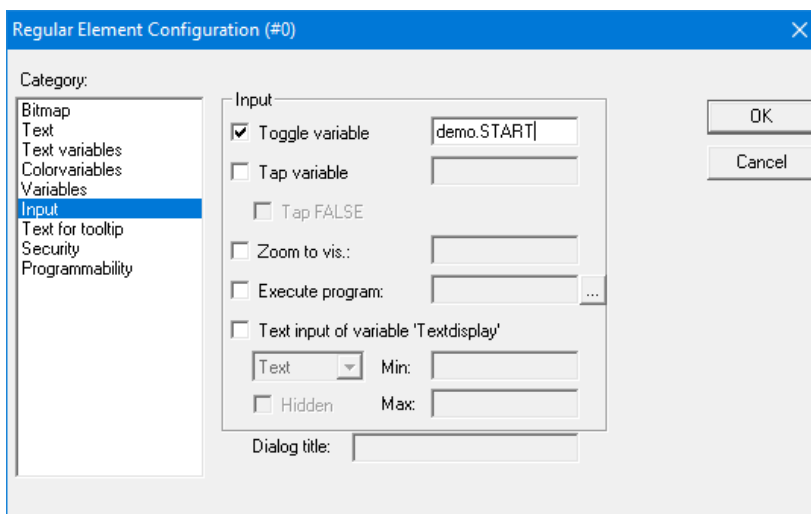

16. We configure this program into task configuration by Resource -> Task configuration -> Right click Task configuration -> Append Task -> Insert t#10ms in Properties in Taskattributes. Then we need to sign our program to this task by right click NewTask-> Append Program Call-> Choose demo(PRG) by clicking the select button in Program Call ->OK.

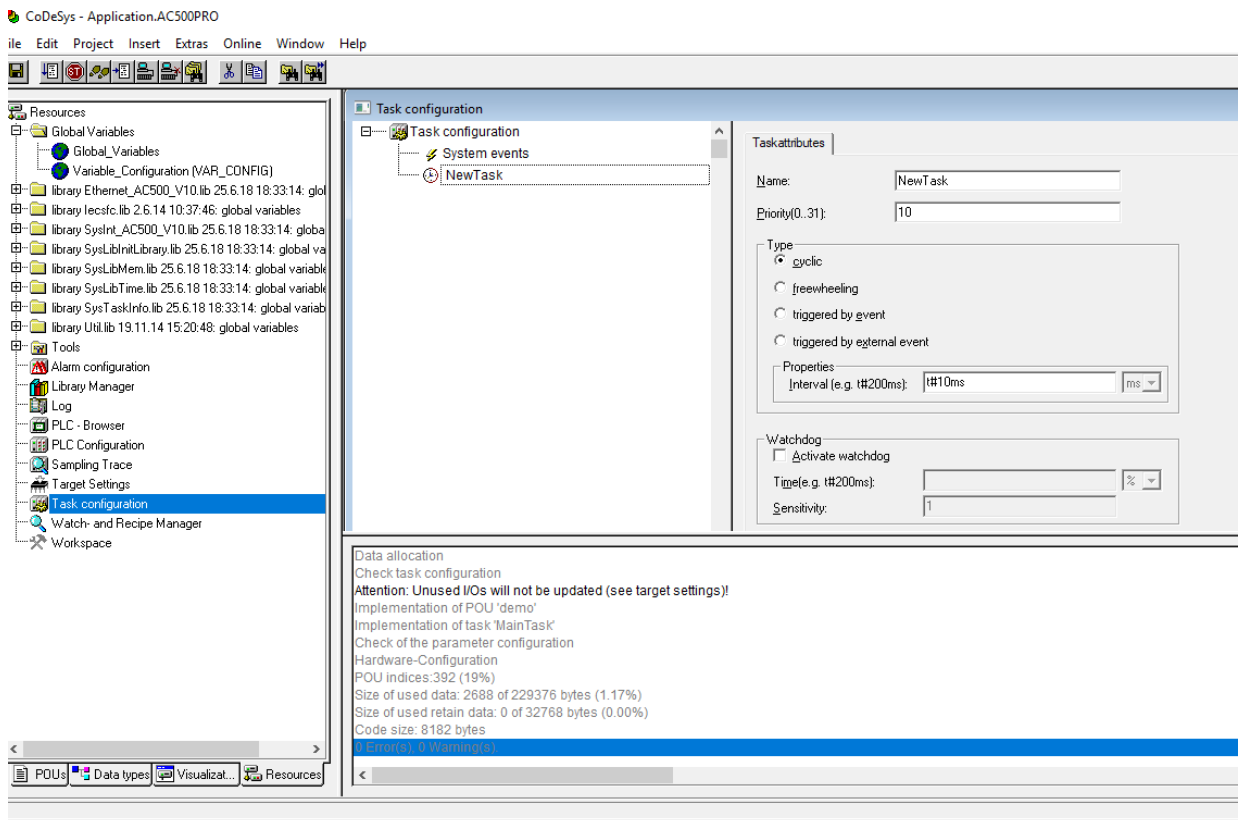

17. Right click on the NewTask and select Append Program Call.

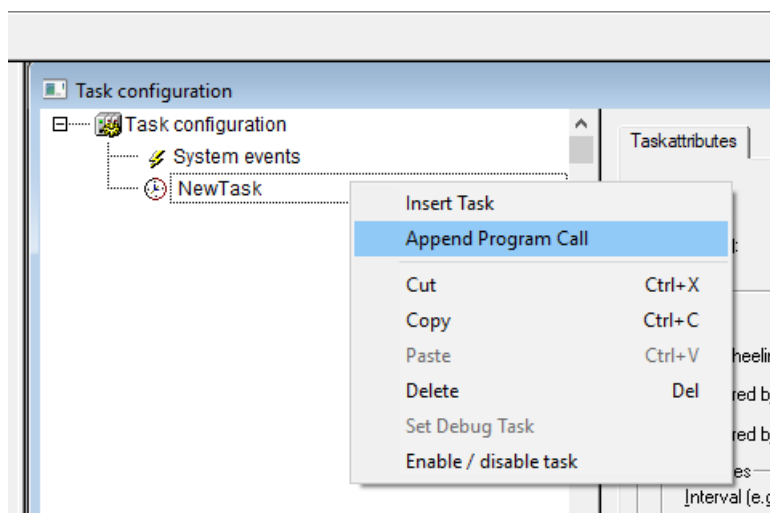

STATUS	SECURITY LEVEL	DOCUMENT ID.	REV.	LANG.	PAGE
Approved	Public	1SFC132089M0201	F	en	33/36

18. Select the demo program call.

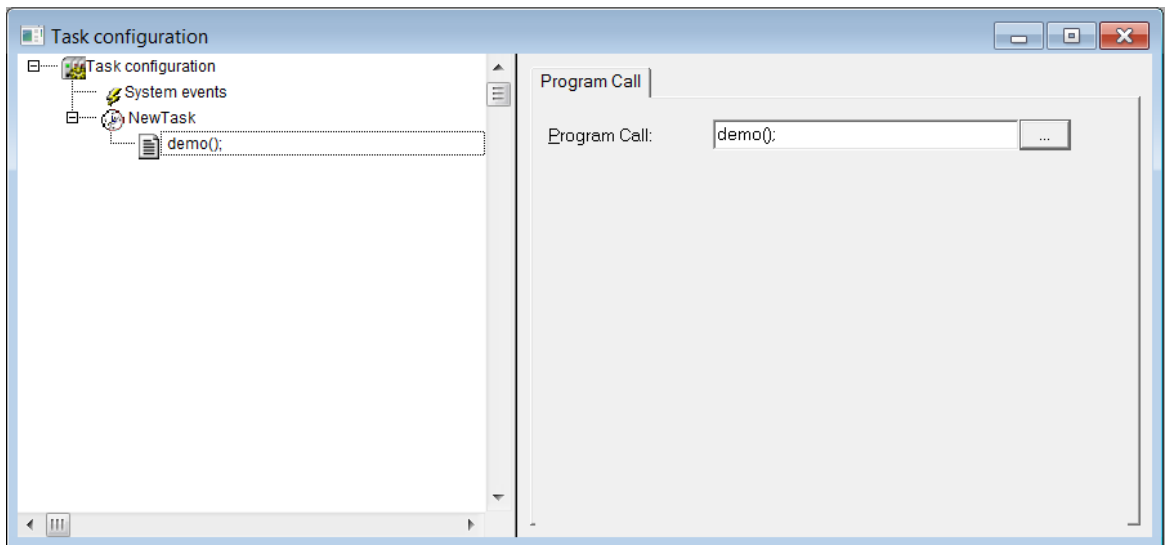

19. Now we can build the project by Project -> Build. Check again if fieldbus is connected correctly. We can then run the program by pressing ALT+F8 and then F5.

7.4. Connect to PLC using TCP/IP

1. Control the IP address for the device is also correct by right click the device name and then chose communication setting. The IP address should be the address of PLC CPU device.

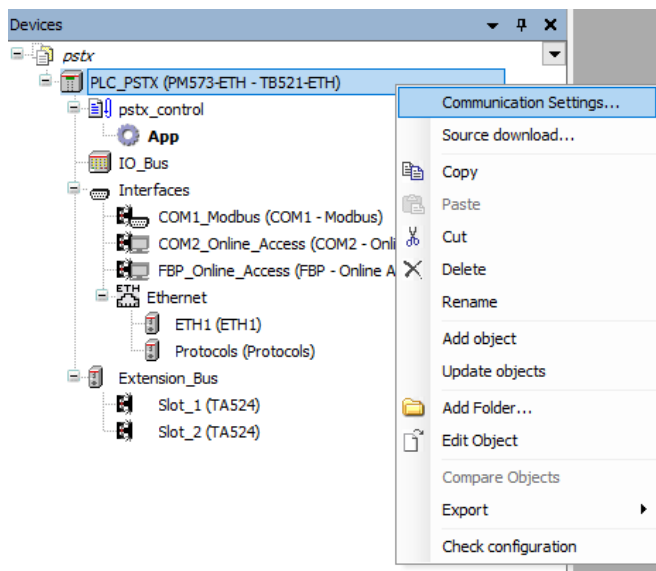

2. Control that the IP address for PC and the PLC is in the same network but not the same IP address. This can be checked by using through Ethernet Properties.

3. Click the icon “Login”, for building the configuration and checking if configuration is correct.
4. If the configuration is correct, a program for building PLC should be opened in the PLC environment, CoDeSys. Automation Builder will ask for downloading PLC configuration. Choose “Update”. Automation Builder will confirm that the program has changed.

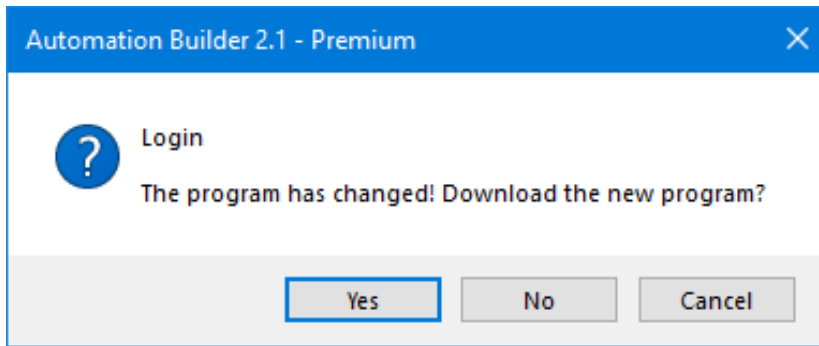
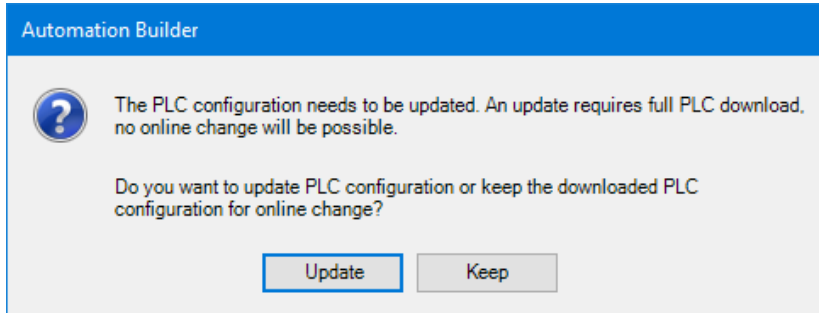

STATUS	SECURITY LEVEL	DOCUMENT ID.	REV.	LANG.	PAGE
Approved	Public	1SFC132089M0201	F	en	35/36

7.5. Build and run the PLC demo program

Use the key, F11, to build the program once. Login and start project from Automation Builder by clicking Alt+F8 to login the CodeSys. Click yes to login

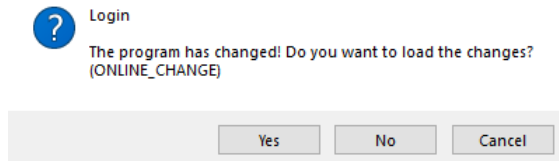

Click F5 to start. Switch to CoDeSys and click Alt+F8 to login demo. The program can be controlled with the view from CodeSys

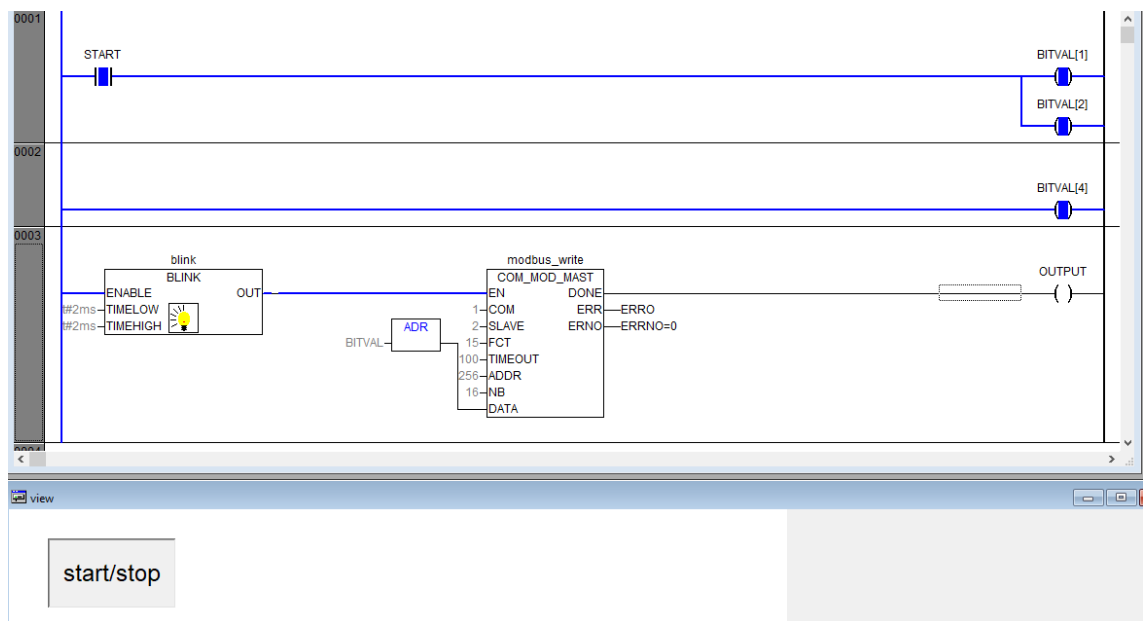

8. Contact us

For more information, please contact your local ABB representative or visit <https://solutions.abb/softstarters>